

Andreu World

Contemporary
Design
Manufacturing
Culture

Outdoor



Andreu World

Contemporary
Design
Manufacturing
Culture

Outdoor





Our concept of al fresco living is not limited to just the country or the beach. We believe that you can enjoy the sun and the breeze on a patio or garden whether it is located in the middle of the city or at your favorite restaurant. Andreu World Outdoor takes that idea and combines it with the nature of the exterior and the comfort of the interior.

The inspiration for the Andreu World Outdoor collections remains nature with a clearly contemporary point of view. They are functional, comfortable and elegant designs that can be used in both private and public environments.

The various Andreu World collections are designed for use in exterior, public, or private applications and include lounge chairs, sofas, modular systems, chairs, tables, side tables and chaise lounges. A combinable offering that was developed from materials resistant to the extremes of climate and intensive use, are respectful of the environment and only require simple maintenance.

En nuestro día a día el concepto de aire libre no se limita al campo o a la playa. Generalmente disfrutamos del sol y la brisa en la terraza o el jardín de nuestro hogar en la ciudad o de nuestro restaurante favorito. Andreu World Outdoor recoge esa idea y combina la naturalidad del exterior con la comodidad del interior.

La inspiración de las colecciones Andreu World Outdoor sigue siendo la naturaleza con un punto de vista claramente contemporáneo. Son diseños funcionales, confortables y elegantes que pueden utilizarse en ambientes privados o colectivos.

Las distintas colecciones de Andreu World pensadas para su uso en ambientes de exterior, colectivos o privados, abarcan butacas, sofás y sistemas modulares, sillas, mesas, mesas auxiliares y también tumbonas. Una oferta combinable entre sí y desarrollada a partir de materiales resistentes a los rigores del clima y al uso intensivo, respetuosos con el medio ambiente y que sólo requieren un sencillo mantenimiento.



010
Aire



044
Sand



092
Dual



118
Sand
Table



016
Brisa



050
Serena Teak



098
Plaza



122
Terra



022
Flex



058
Siesta



102
Quattro



126
Wind



026
Landscape
Alu



066
Sit



106
Raglan
Table



034
Sail



074
Trenza



112
Reverse

Aire Outdoor has a light and balanced character, adaptable to all types of exterior environments. It is comfortable, subtle, and extremely durable in all versions.

This new outdoor collection is offered in armchair, lounge chair and chaise lounge versions.

Aire Outdoor tiene un carácter ligero y equilibrado, adaptable a todo tipo de ambientes de exterior. Es cómoda, sutil y sumamente estable en todas sus versiones.

Esta nueva colección outdoor se presenta con las versiones sillón, butaca y tumbona.

Aire

by Piergiorgio Cazzaniga



**Residential
Hogar**

▼ SO 1280

Armchair with aluminum frame and seat and back upholstered in Balyline® mesh. Steel sled base with EPL-5 treatment and available in white or brown. Available loose cushion seat and backrest.

Sillón con asiento y respaldo con estructura de aluminio y tapizado en Balyline® y base de patín de acero EPL-5 en acabado blanco o marrón tierra. Disponible cojín auxiliar asiento y respaldo.

**Residential
Hogar**

▼ TU 1262

Chaise lounge with reclining back, aluminum frame and seat and back upholstered in Balyline® mesh. Steel sled base with EPL-5 treatment and available in white or brown. Available loose cushion seat and backrest.

Tumbona de respaldo reclinable con asiento y respaldo con estructura de aluminio y tapizado en Balyline® y base de patín de acero EPL-5 en acabado blanco o marrón tierra. Disponible cojín auxiliar asiento y respaldo.



◀ SO 1280
Armchair with aluminum frame and seat and back upholstered in Balyline® mesh. Steel sled base with EPL-5 treatment and available in white or brown. Available loose cushion seat and backrest.
Sillón con asiento y respaldo con estructura de aluminio y tapizado en Balyline® y base de patín de acero EPL-5 en acabado blanco o marrón tierra. Disponible cojín auxiliar asiento y respaldo.

◀ BU 1281
Lounge chair with aluminum frame and seat and back upholstered in Balyline® mesh. Steel sled base with EPL-5 treatment and available in white or brown. Available loose cushion seat and backrest.
Butaca con asiento y respaldo con estructura de aluminio y tapizado en Balyline® y base de patín de acero EPL-5 en acabado blanco o marrón tierra. Disponible cojín auxiliar asiento y respaldo

Cafetería
Cafetería
◀ SO 1280

Cafetería
Cafetería
▼ BU 1281



The Brisa collection evokes a sense of lightness and gentleness. Its form brings to mind the classic folding chair while harmonizing its practicality, durability, and versatility to the fullest.

The woven seat and backrest are handmade: a combination of artisanal craftsmanship and new materials that perfectly matches the concept embodied in this chair.

Brisa es una evocación ligera y amable. Su forma nos trae a la memoria las sillas plegables de siempre, pero sintetizada al máximo, con su practicidad, resistencia y polivalencia potenciadas al máximo.

El cinchado del asiento y del respaldo están realizados a mano: una combinación de técnica artesanal y de nuevos materiales que encaja perfectamente con el concepto que encarna esta silla.

Brisa

by Lievore Altherr Molina



Cafeteria

Cafetería

▼ SI 0770

Folding chair. Woven bands
on seat and back.
Silla plegable. Cincha en
asiento y respaldo.



Residencial

Hogar

▼ SI 0770





Terrace
Terraza
▼ SI 0770



Residential
Hogar
▶ ▼ SI 0770



The iconic form of the Flex Outdoor is now offered for exterior use. It is made with resilient materials and treatments, such as EPL5 technology that protects the piece from environmental damage. This evolution of the Flex Outdoor comes accompanied by a new range of colors with a mango green tone, which emphasizes the outdoor character of this new version.

La forma icónica de Flex Outdoor ahora se presenta para su uso en exteriores. Está realizada con materiales resistentes y tratamientos, como la tecnología EPL5, que preserva completamente este diseño de las agresiones ambientales. Esta evolución de Flex Outdoor viene acompañada de una nueva gama de colores con un tono verde mango, que enfatiza el carácter outdoor de esta nueva versión.

Flex Chair

by Piergiorgio Cazzaniga





◀ **BQ 1328**

Outdoor barstool with thermo-polymer shell and sled base finished in titanium, white or earth brown.
Banqueta con asiento y respaldo de termopolímero y base de varilla de patín de acero en acabado titanio, blanco o marrón tierra.

▼ **SI 1322**

Outdoor stackable chair with thermo-polymer shell and sled base finished in titanium, white or earth brown.
Silla con asiento y respaldo de termopolímero y base de varilla de patín de acero en acabado titanio, blanco o marrón tierra.

▼ **SI 1320**

Outdoor stackable chair with thermo-polymer shell and 4 steel legs finished in titanium, white or earth brown.
Silla con asiento y respaldo de termopolímero y base de 4 patas de tubo de acero en acabado titanio, blanco o marrón tierra.

Cafeteria

Cafetería

▶ **SI 1322**



Maximum comfort is also possible for the outdoors. The sofas and chaise lounges of the Landscape Alu series are intended for complete exterior use thanks to their aluminum structure. Durable and requiring only light maintenance, the Landscape Alu adapts to all types of environments, domestic and public, that call for seating that is both comfortable and stylish.

El máximo confort también es posible al aire libre. Los sofás y tumbonas de la serie Landscape Alu están concebidas para un uso 100% exterior gracias a su estructura de aluminio. Resistente y con un mantenimiento fácil, la serie Landscape Alu se adapta a todo tipo de ambientes, domésticos o colectivos, que demanden asientos muy confortables y representativos.

Landscape Alu

by Lievore Altherr Molina



Residential

Hogar

▼ SF 4636

3 seater sofa. Upholstered seat and backrest. Earth Brown aluminum frame finish. Left seat is backless. Sofá de tres plazas. Asiento y respaldo tapizado. Estructura de aluminio Marrón Tierra. Plaza izquierda sin respaldo.

▼ SF 4637

3 seater sofa. Upholstered seat and backrest. Earth Brown aluminum frame finish. Right seat is backless. Sofá de tres plazas. Asiento y respaldo tapizado. Estructura de aluminio Marrón Tierra. Plaza derecha sin respaldo.

▼ TU 4638

Chaise lounge with wheels, reclining backrest. Upholstered cushion. Earth Brown aluminum frame finish. Tumbona con ruedas, respaldo reclinable. Cojín tapizado. Estructura de aluminio Marrón Tierra.





Residential
Hogar
◀ SF 4637
◀ TU 4638
Residential
Hogar
▼ SF 4637





Hotel terrace
Terraza hotel
◀ TU 4638

◀ SF 4633
3 seater sofa with arms,
upholstered seat and backrest
and aluminum frame in Earth
Brown finish.
Sofá de tres plazas con brazos,
con asiento y respaldo tapizado
y estructura de aluminio en
acabado Marrón Tierra.

Hotel terrace
Terraza hotel
▼ SF 4633

One of our most iconic and versatile products. Its form, seemingly simple, and its color finishes make it a chair capable of adapting to any environment or use. Sail is made with highly durable thermo-polymer. It is stackable, easy to maintain, and provides exceptional functionality. Sail is a quintessential chair conceived from an exhaustive study of design and technology.

Es uno de nuestros productos más icónicos y polivalentes. Su forma, aparentemente sencilla, y sus acabados de color la convierten en una silla capaz de adaptarse a cualquier ambiente y función. Sail está realizada con termopolímero altamente resistente. Es apilable, fácil de mantener y ofrece una funcionalidad excepcional. Sail es una silla paradigmática concebida a partir de un estudio exhaustivo del diseño y de la tecnología.

Sail

by Piergiorgio Cazzaniga



Waiting area
Zona de espera
▼ SI 1245
Stackable chair in thermo-polymer.
Silla apilable de termopolímero.



Restaurant
Restaurante
▼ SI 1245

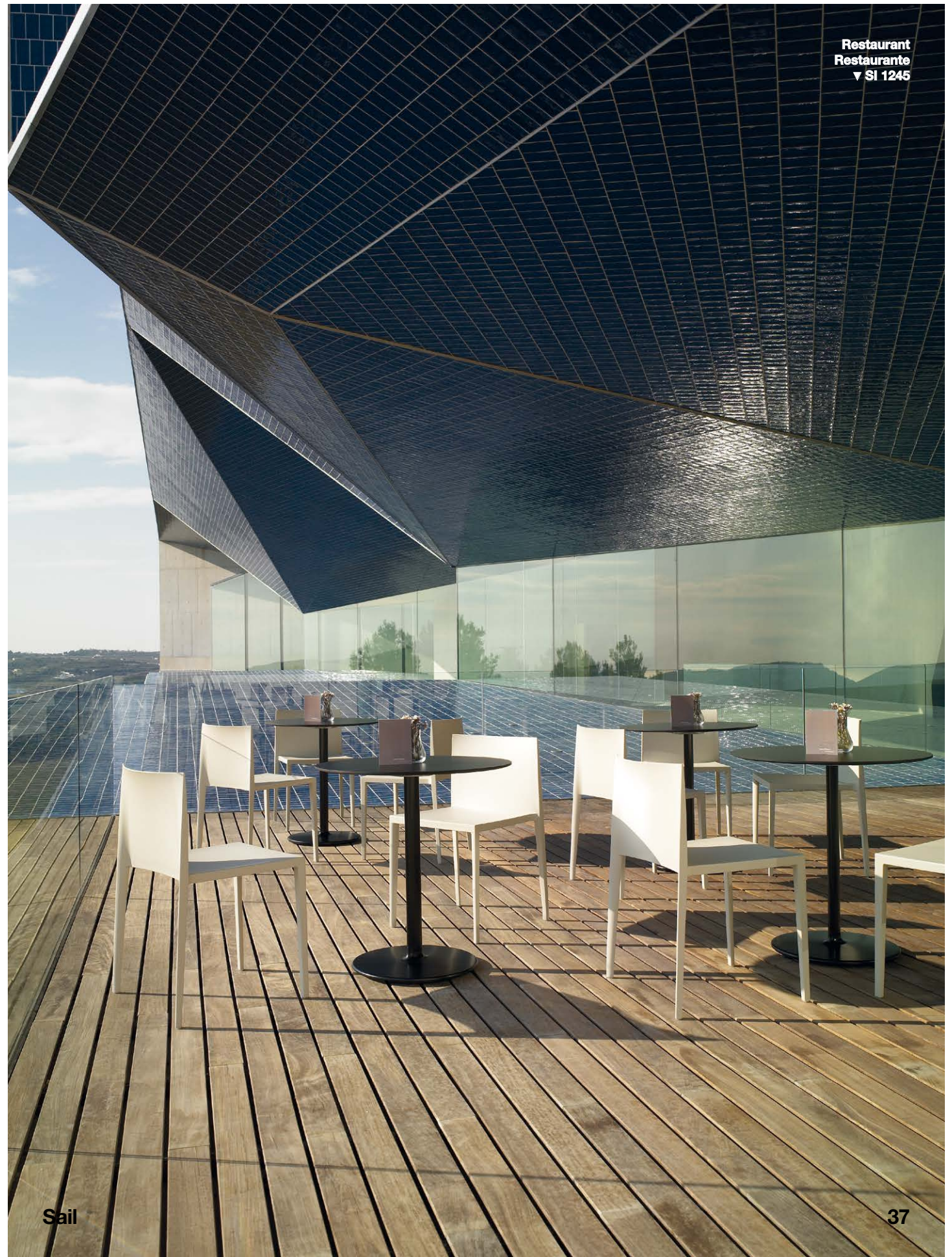

Cafeteria
Cafeteria
▼ SI 1245
▼ SI 1245



Restaurant
Restaurante
▼ SI 1245





Restaurant
Restaurante
◀ SI 1245

Restaurant
Restaurante
▲ SI 1245

◀ SI 1245



Workspace
Espacio de trabajo
▼ SI 1245

Workspace
Espacio de trabajo
► SI 1245



Comfort in outdoor environments, both private and public, can be achieved from these light and fresh sofas that are versatile and constructed with environmentally friendly materials. Sand is exemplar in all aspects and is offered in various color options for the frame, woven bands, and upholstery.

El confort en los ambientes de exterior, tanto privados como colectivos, puede lograrse a partir de sofás ligeros y frescos, versátiles y realizados a partir de materiales respetuosos con el medio ambiente. Sand es ejemplar en todos estos aspectos y se ofrece en distintas opciones cromáticas para la estructura, el cinchado y la tapicería.

Sand

by Lievore Altherr Molina





**Hotel terrace
Terraza hotel**

▲ SF 4305

▲ ME 4315

Coffee table. Earth Brown.
Decorative Technical stone
table top in Earth Brown.
Mesa de centro. Marrón
tierra. Sobre de Cerámica
Decorativa Marrón Tierra.

► SF 4300

3 seater sofa. Woven
bands on backrest and
arms. Steel frame with
EPL-5 outdoor treatment
White finish, 4 cushions
backrest.

Sofá de tres plazas.
Respaldo y brazos
cinchados. Estructura de
acero EPL-5 para exterior
Blanca. Respaldo de 4
cojines.



**Hotel terrace
Terraza hotel**

▼ SF 4305

3 seater sofa. Woven bands on
backrest and arms. Steel frame
with EPL-5 outdoor treatment
Earth Brown finish, 2 cushions
backrest.

Sofá de tres plazas. Respaldo y
brazos cinchados. Estructura de
acero EPL-5 para exterior Marrón
Tierra. Respaldo de 2 cojines.



Residential
Hogar

◀ SF 4300

Restaurant
Restaurante

▼ SF 4300

Serena Teak expresses elegance, naturalness and contemporary aesthetics. To enhance its exterior use and give greater resistance against the impact of the elements, it is now presented in an entirely teak version. Maintaining its elevated comfort, distinctive braided straps and it adapts perfectly to residential and hospitality installations.

Serena Teak expresa elegancia, naturalidad y estética contemporánea. Ahora, para potenciar su uso en exteriores y su resistencia al impacto de los elementos, se presenta íntegramente en madera de teca. Mantiene su elevado confort, su trenzado de cinchas característico y se adapta sin problemas a ambientes residenciales o de instalación.

Serena Teak

by Lievore Altherr Molina



Cafetería

Cafetería

▼ **SI 1190**

Chair with webbing seat and backrest and solid teak wood frame. Suitable for outdoor use.
Silla con asiento y respaldo cinchado y estructura de madera maciza de teca. Válida para uso en exterior.

▼ **SO 1191**

Armchair with webbing seat and backrest and solid teak wood frame. Suitable for outdoor use.
Sillón con asiento y respaldo cinchado y estructura de madera maciza de teca. Válida para uso en exterior.





Terrace
Terraza
◀ BU 1192
 Lounge chair with webbing seat and backrest and solid teak wood frame. Low back version. Suitable for outdoor use.
 Butaca de respaldo bajo con asiento y respaldo cinchado y estructura de madera maciza de teca. Válida para uso en exterior.

Terrace
Terraza
▼ BU 1193
 Lounge chair with arms webbing seat and backrest. Solid teak wood frame. Low back version. Suitable for outdoor use.
 Butaca de respaldo bajo con brazos, asiento y respaldo cinchado y estructura de madera maciza de teca. Válida para uso en exterior.

Terrace
Terraza
▶ BU 1193



**Terrace
Terraza**

▼ **BU 1194**

Lounge chair with webbing seat and backrest and solid teak wood frame. High back version. Suitable for outdoor use.

Butaca de respaldo alto con asiento y respaldo cinchado y estructura de madera maciza de teca. Válida para uso en exterior.

▼ **RS 1196**

Ottoman with webbing seat and solid teak wood frame.

Suitable for outdoor use.

Reposapiés con asiento cinchado y estructura de madera maciza de teca. Válida para uso en exterior.



**Terrace
Terraza**

► **BU 1195**

Lounge chair with arms and webbing seat and backrest and solid teak wood frame. High back version. Suitable for outdoor use.

Butaca de respaldo alto con brazos, asiento y respaldo cinchado y estructura de madera maciza de teca. Válida para uso en exterior.

Terrace

Terraza

▼ **BU 1195**

▼ **RS 1196**



The versatility of the Siesta is the combination of comfort and modularity, finish offer and beauty of its forms. Its use in exterior and interior is only dependent on the upholstery selection. Its steel frame with special treatment for exterior use, provides great resistance and durability.

Siesta permits numerous configurations, from the lounge chair or two-seater sofa, to large sofa with corner modules, footrests, and occasional tables.

La versatilidad de Siesta es una suma de confort, modularidad, oferta de acabados y belleza en las formas. Su utilización en exteriores o interiores sólo depende de la elección de la tapicería. Su estructura de acero con un tratamiento especial para su uso en exterior, le ofrece una gran resistencia y durabilidad.

Siesta permite distintas configuraciones, desde una butaca o un asiento de dos plazas hasta un gran sofá con módulos rinconeros, reposapiés y mesa auxiliar.

Siesta

by Lievore Altherr Molina



**Residential
Hogar**

▼ **SF 4755**

Left corner sofa module. EPL-5 treated steel sled base in Earth Brown.

Módulo rinconero. Lado izquierdo. Estructura de patín de acero y tratamiento EPL-5 Marrón Tierra.

▼ **SF 4750**

Central sofa module. EPL-5 treated steel sled base in Earth Brown.

Módulo central. Estructura de patín de acero y tratamiento EPL-5 Marrón Tierra.

▼ **SF 4750**

▼ **SF 4751**

Right corner sofa module. EPL-5 treated steel sled base in Earth Brown.

Módulo rinconero. Lado derecho. Estructura de patín de acero y tratamiento EPL-5 Marrón Tierra.





**Residential
Hogar**
▲ SF 4750
▲ RS 4754
Ottoman. EPL-5 treated steel sled
base in Earth Brown.
Reposapiés. Tratamiento EPL-5
Marrón Tierra.

**Residential
Hogar**
▶ SF 4755
▶ SF 4750
▶ SF 4751



Residential
Hogar
▼ RS 4754
▼ SF 4750 x 2
▼ SF 4751

Hotel terrace
Terraza hotel
▶ SF 4750 x 2

Hotel terrace
Terraza hotel
▶ SF 4755
▶ SF 4750 x 2
▶ SF 4751
▶ SF 4750
▶ RS 4754



From its essential form developed a series of chairs, armchairs, barstools and counter stools especially suitable for gathering and amenity spaces. It comes in several versions including four-legged and sled base and in many different thermo-polymer finishes. It is stackable and requires only basic maintenance.

A partir de una forma esencial se ha desarrollado un sistema de sillas, sillones y banquetas altas y bajas especialmente aptas para colectividades e instalaciones. Se ofrece en versiones con cuatro patas, patín y en diferentes acabados de color de termopolímero. Es apilable y tiene un mantenimiento básico.

Sit

by Lievore Altherr Molina





**Restaurant
Restaurante**
◀ SI 1235
Stackable chair. Thermo-
polymer seat and backrest.
4-legged steel base finished
in Titanium.
Silla apilable. Asiento y
respaldo de termopolímero.
Estructura de 4 patas de
acero en color Titanio.

**Cafeteria
Cafetería**
▼ SI 1235





Cafeteria
Cafeteria
 ◀ SI 1235

Cafeteria
 ▲ SI 1237
 Stackable chair. Thermopolymer seat and backrest. Steel sled base finished in Titanium.
 Silla apilable. Asiento y respaldo de termopolímero. Estructura de base de patín de acero en color Titanio.

▶ SI 1235





Cafetería terraza
Terraza cafetería
▼ BQ 1238

Stackable barstool. Thermo-polymer seat and backrest. Steel sled base finished in Titanium.
Banqueta apilable. Asiento y respaldo de termopolímero. Estructura de base de patín de acero color Titania.



This system of seating encompasses chairs, lounge chairs, stools and chaise lounges. Highlighted for its visually light steel structure and the woven bands that form a continuous seat and backrest. All of the materials, webbing, and frame, are designed to resist damage from exposure to weather: the design remains unchanged over time. Features stackable versions that adapt perfectly to any outdoor project.

Este sistema de asientos abarca sillas, butacas, taburetes y tumbonas. Destaca por su estructura de acero muy ligera visualmente y por el cinchado continuo de asiento y respaldo. Todos los materiales –cincha y estructura– están pensados para resistir a los agentes climáticos: el diseño permanece inalterable en el tiempo. Cuenta con versiones apilables que se adaptan perfectamente a cualquier proyecto colectivo al aire libre.

Trenza

by Lievore Altherr Molina





◀ **SI 0700**
Stackable chair. EPL-5 treated steel sled base in Earth Brown. Woven band on seat and back.
Silla apilable. Estructura de patín de acero y tratamiento EPL-5 Marrón Tierra. Cíncha en asiento y respaldo.

**Residential
Hogar**
◀ **SI 0700**

**Restaurant
Restaurante**
◀ **SI 0700**

**Residential
Hogar**
▼ **SI 0700**



Restaurant terrace
Terraza restaurante
▼ SI 0700



Convention Hall terrace
Terraza Centro de Convenciones
▼ SI 0700





Restaurant terrace
Terraza restaurante
▲ SI 0700

► **SO 0701**
 Stackable armchair. EPL-5 treated steel sled base in Earth Brown.
 Woven band on seat and back.
 Sillón apilable. Estructura de patín de acero y tratamiento EPL-5 Marrón Tierra. Cincha en asiento y respaldo.

Restaurant terrace
Terraza restaurante
► SO 0701



Trenza

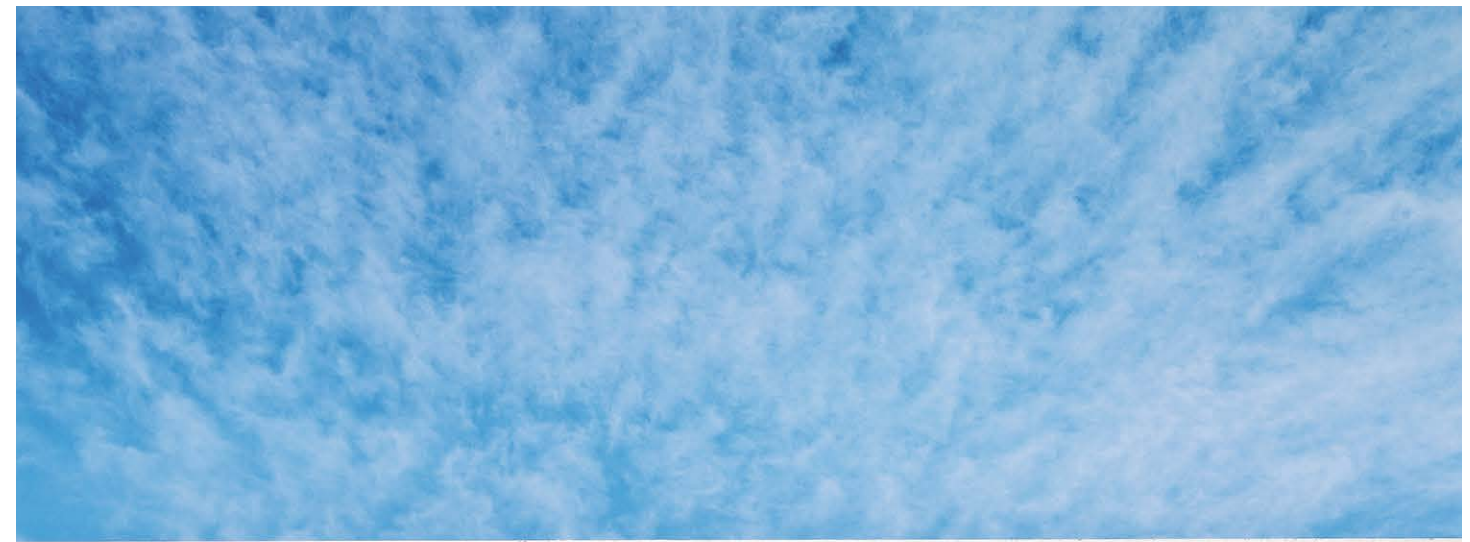

Trenza

► **BQ 0705**
Barstool. EPL-5 treated steel sled base in Earth Brown. Woven band on seat and back.
Banqueta. Estructura de patín de acero y tratamiento EPL-5 Marrón Tierra. Cincha en asiento y respaldo.

Cafetería
Cafetería
▼ **BQ 0705**

Cafetería terraza
Terraza cafetería
► **BQ 0705**

Cafetería
Cafetería
► **BQ 0705**

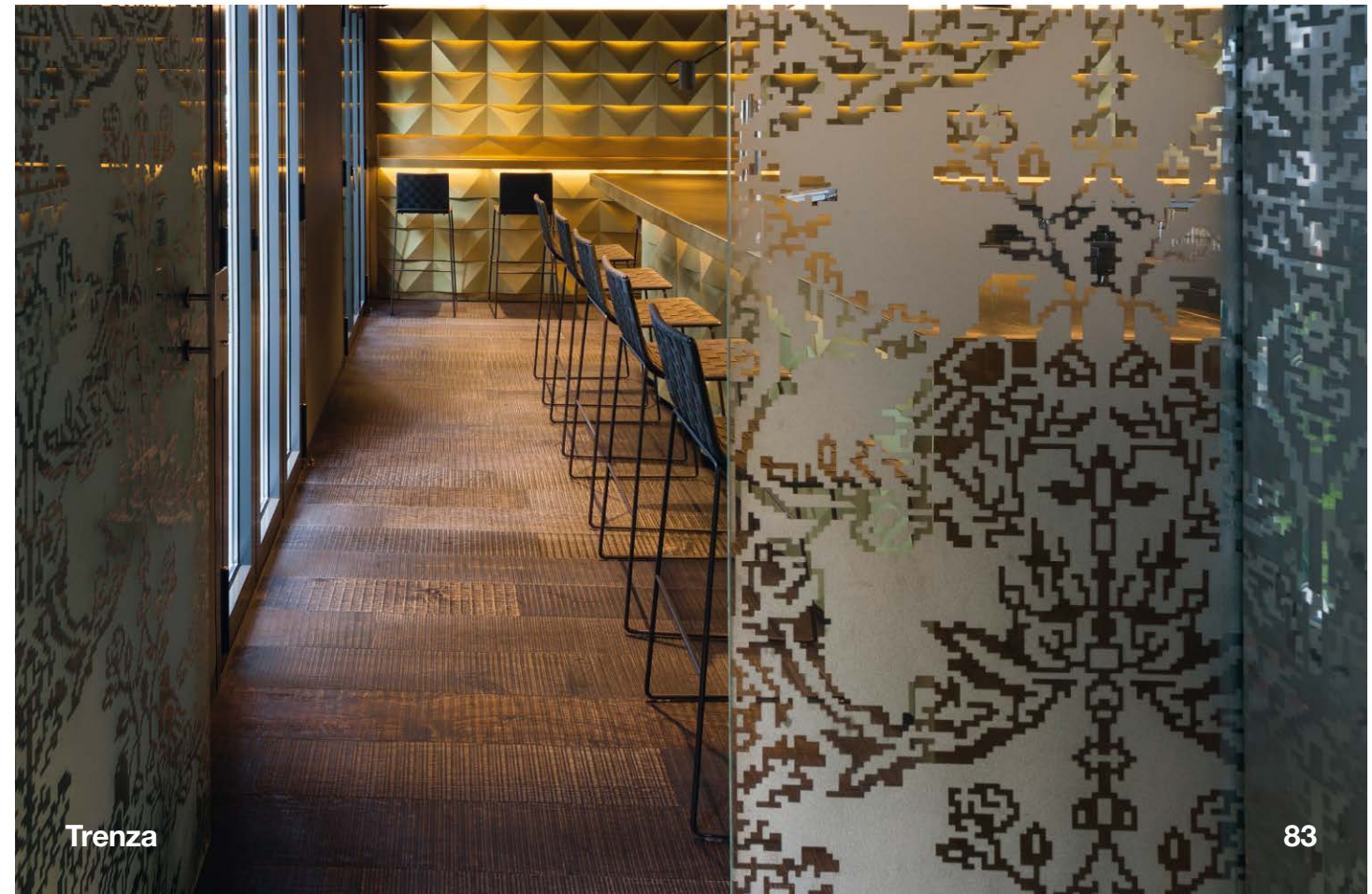



**Cafeteria terraza
Terraza cafetería
▼ BU 0703**

Lounge chair with arms. EPL-5 treated steel sled base in White. Woven band on seat and back. Butaca con brazos. Estructura de patín de acero y tratamiento EPL-5 en Blanco. Cincha en asiento y respaldo.



**Residencial
Hogar
▼ BU 0702**

Lounge chair. EPL-5 treated steel sled base in Earth Brown. Woven band on seat and back. Butaca. Estructura de patín de acero y tratamiento EPL-5 Marrón Tierra. Cincha en asiento y respaldo.



Residential
Hogar

◀ BU 0702

◀ BU 0703

Hotel terrace
Terraza hotel

◀ BU 0702

Cafeteria terrace
Terraza cafetería

◀ BU 0703



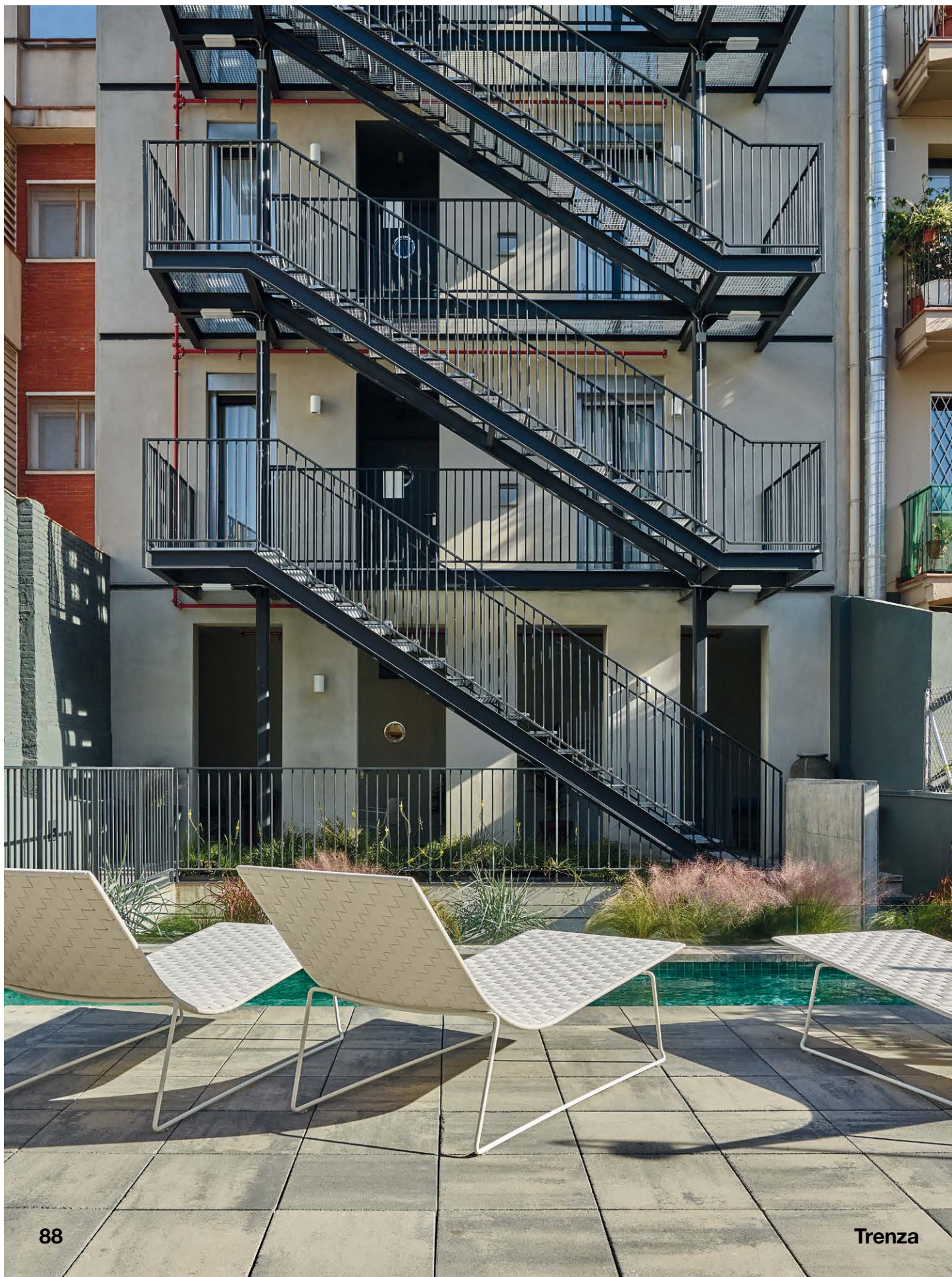

Hotel terrace
Terraza hotel
◀ TU 0704
Chaise Lounge. EPL-5
treated steel sled base in
White. Woven band on
seat and back.
Tumbona. Estructura
de patín de acero y
tratamiento EPL-5 en
Blanco. Cincha en asiento
y respaldo.

Hotel terrace
Terraza hotel
▼ TU 0704



The light, svelte, and functional Dual is characterized by the oval shape of its column and is available in four heights with a circular injected aluminum base. It is able to be combined with all types of seating and complements the sofas and lounge chairs in its occasional version. Dual is timeless, elegant, and versatile.

Ligera, esbelta y funcional, Dual se caracteriza por la forma ovalada de su columna, disponible en cuatro alturas, y por su base circular de aluminio inyectado. Combina con todo tipo de asientos y complementa a sofás y butacas en su versión "occasional". Dual es atemporal, elegante y versátil.

Dual

by Lievore Altherr Molina





Cafetería
Cafetería

◀ **BM 4361 Dual 45+SB 4572 Compacto HPL**
Aluminum table base in Black finish and square Compacto high pressure laminate (HPL) table top.
Base de mesa de aluminio con acabado Negro y sobre de tablero Compacto laminado cuadrado (HPL) Blanco.

◀ **BM 4361 Dual 45+SB 4581 Compacto HPL**
Aluminum table base in White finish and round Compacto high pressure laminate (HPL) table top. White finish.
Base de mesa de aluminio con acabado Negro y sobre redondo de tablero Compacto laminado cuadrado (HPL). Acabado Blanco.

Cafetería
Cafetería

▼ **BM 4361 Dual 45+SB 4581 Compacto HPL**

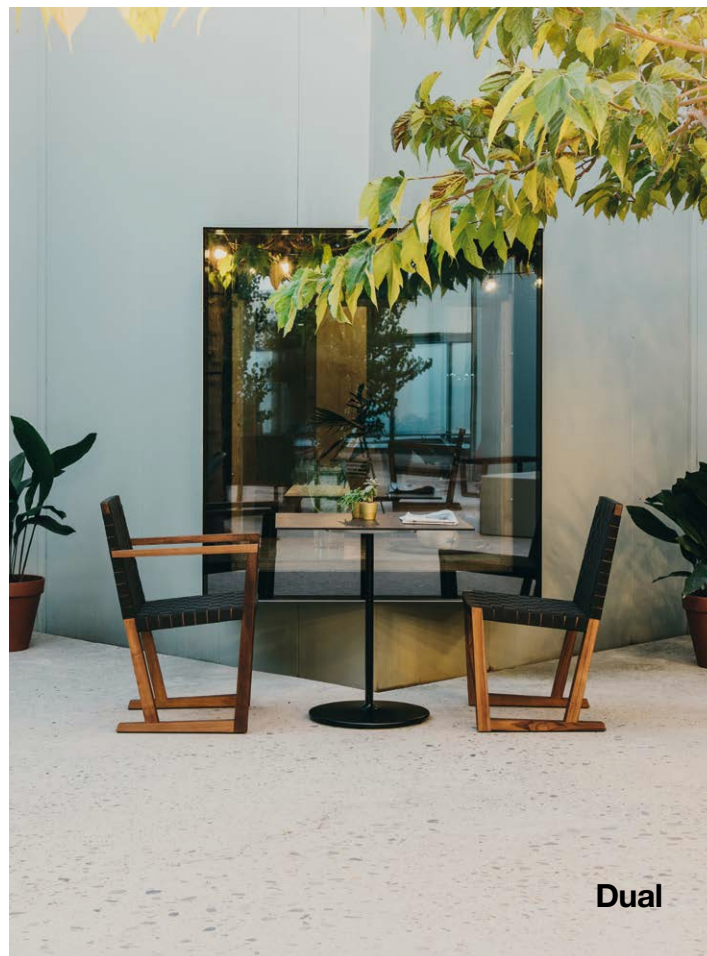



Cafeteria
Cafeteria
 ◀ **BM 4361 Dual 45+SB 4581 Compacto HPL**

Dual Ocasional
 ◀ **ME 6435 (Altura 40cm/19.75 in height)**
 ◀ **ME 6450 (Altura 50cm/15.75 in height)**
 Occasional table with round base and oval injected aluminum column in White finish and round Compact board table HPL.
 Mesa auxiliar con base redonda y columna ovalada de inyección de aluminio en acabado Blanco y sobre redondo Blanco de tablero Compacto HPL.

Cafeteria
Cafeteria
 ▼ **BM 4361 Dual 45+SB 4581 Compacto HPL**



Combines with all of the outdoor table tops from our catalog and is defined by an injected aluminum column with a stable and solid base. Plaza is harmonic when it is used together for gathering spaces and it is visually discreet when used individually.

Combina con todos los sobres outdoor de nuestro catálogo y se caracteriza por una columna de aluminio inyectado con una base estable y sólida. Plaza es armónica cuando se emplea en grupo, en proyectos colectivos, y visualmente discreta situada individualmente.

Plaza

by Estudio Andreu





**Restaurant
Restaurante**

◀ **BM 1114 Bar height/Altura bar-SB 3593 Top Solid Surface**

Central table base with square aluminum column and base in White finish. Square Solid Surface table top.
Base central de mesa con columna y base cuadrada de aluminio y sobre Top Solid Surface cuadrado. Acabado Blanco.

**Restaurant
Restaurante**

▲ **BM 1112+SB 4537 Technical stone table top**

Central table base with round aluminum column and square base in White finish. Square Solid Surface table top.
Base central de mesa con columna redonda y base cuadrada de aluminio y sobre Top Solid Surface cuadrado. Acabado Blanco

▶ **BM 1112+SB 4582 Top Compacto HPL**

Central table base with round aluminum column and square base in White finish. Round Compac HPL board table top.
Base central de mesa con columna redonda y base cuadrada de aluminio y sobre Top Compacto HPL redondo. Acabado Blanco.



As dynamic as it is strong and stable, Quattro combines with our many outdoor table tops and adapts to the height of the chairs, stools, or lounge chairs and sofas that it accompanies.

Quattro fits without problems in exterior applications whether they be private or public when combined with our wide range of seating collections.

Tan dinámica como robusta y estable, Quattro combina con los distintos sobres de nuestra colección outdoor y se adapta en altura a su uso con sillas, taburetes o acompañando a butacas y sofás.

Quattro encaja sin problemas en ambientes de exterior, privados o colectivos, combinada con nuestra amplia gama de colecciones de asientos.

Quattro

by Lievore Altherr Molina





Cafeteria
Cafetería
◀ BM 4728+SB 3599 Top Solid Surface
 4 star aluminum central table base in Black finish and round Solid Surface table top.
 Base central de 4 aspas de aluminio en acabado Negro y sobre Top Solid Surface redondo.

Cafeteria
Cafetería
▶ BM 4704+SB 4536 Technical stone table top
 4 star aluminum central table base in White finish and square Technical stone table top. Stone Grey finish.
 Base central de 4 aspas de aluminio en acabado Blanco y sobre cuadrado de Cerámica decorativa Gris Piedra.

Hotel
Quattro Occasional
▼ ME 6798
 Occasional table with 4 star aluminum base and round Compact board top HPL. Black finish.
 Mesa auxiliar con base de 4 aspas de aluminio y sobre redondo de tablero Compacto HPL. Acabado Negro.



Its elemental and discreet forms make it perfect to combine with any sofa or lounge chair from our exterior catalog and allows the creation of various configurations. Its aluminum frame added to high pressure laminate or technical stone tops makes it the ideal occasional table for outdoor environments.

Sus formas esenciales y discretas la hacen perfecta para combinar con cualquier sofá o butaca de nuestro catálogo de exterior y permite crear distintas combinaciones. Su estructura de aluminio sumada a los sobres compactos HPL o cerámicos la convierten en una mesa auxiliar idónea para ambientes outdoor.

Raglan Table

by Piergiorgio Cazzaniga

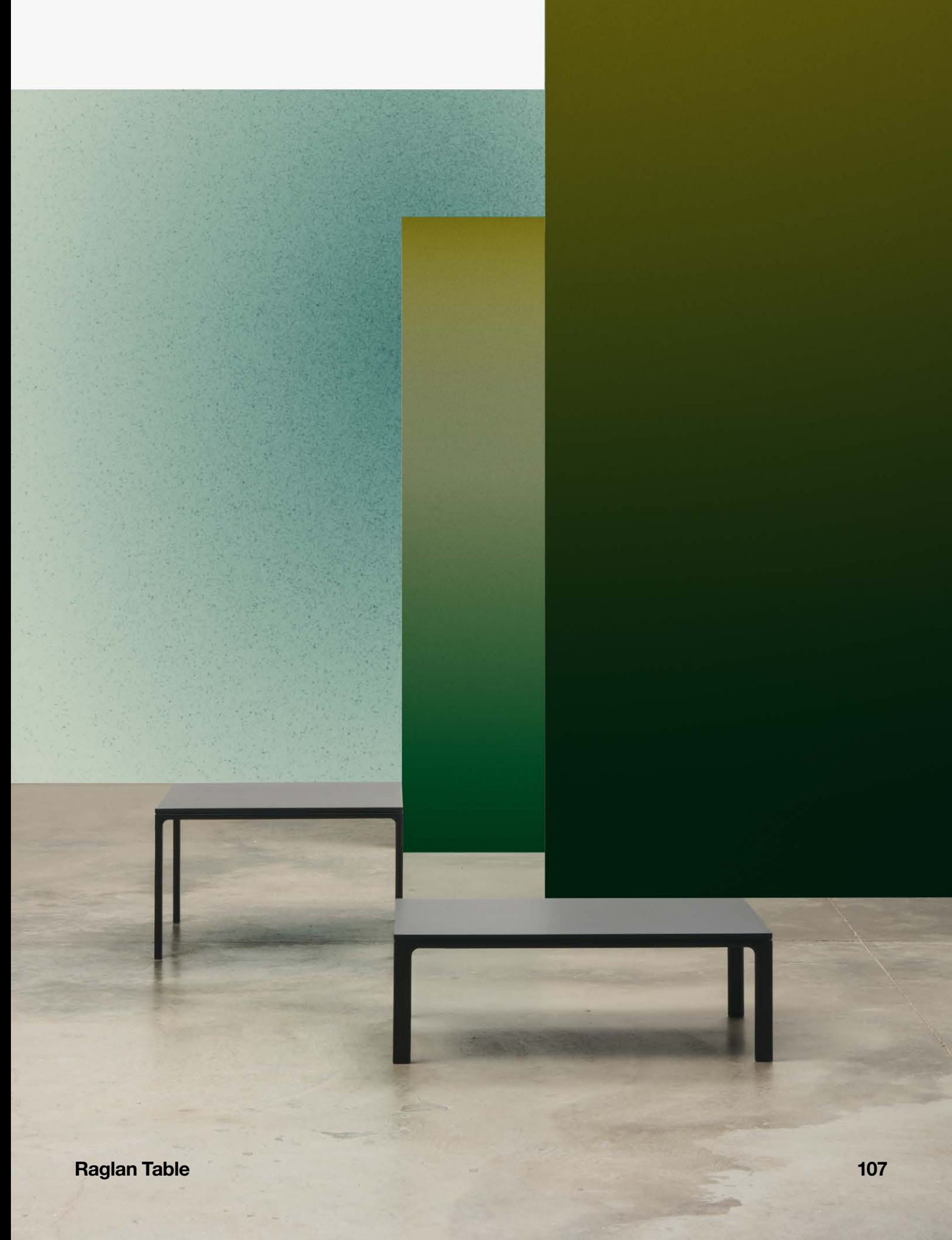



Cafeteria

Cafetería

▼ **ME 8677**

Occasional table with aluminum base in White finish and rectangular Compact HPL board top. Rectangular.

Mesa auxiliar con base de aluminio en acabado Blanco y sobre rectangular de tablero Compacto HPL. Rectangular.

▼ **ME 8687**

Occasional table with aluminum base in White finish and rectangular Compact HPL board top. Square.

Mesa auxiliar con base de aluminio en acabado Blanco y sobre rectangular de tablero Compacto HPL. Cuadrada.

► **ME 8697**

Occasional table with aluminum base in Matte Black finish and rectangular Compact HPL board top.

Mesa auxiliar con base de aluminio en acabado Negro Mate y sobre rectangular de tablero Compacto HPL. Cuadrada.





Cafeteria
Cafetería
◀ **ME 8677**
Occasional table with aluminum base in Matte Black finish and square Technical stone top.
Mesa auxiliar con base de aluminio en acabado Negro Mate y sobre cuadrado cerámico.
▼ **ME 8697**
Occasional table with aluminum base in Matte Black finish and rectangular Compact HPL board top.
Mesa auxiliar con base de aluminio en acabado Negro Mate y sobre rectangular de tablero Compacto HPL.

From an iconic shape has developed a collection of tables that includes distinct sizes, uses, heights and performance. Reverse is a base made from 100% recyclable polyethylene, extremely stable and able to be adapted to total types of uses, from the corporate conference table to a table for a home patio or a commercial project. This adaptability has increased with the Occasional version, conceived to be a complement for sofas and lounge chairs.

A partir de una forma icónica se ha desarrollado un sistema de mesas que abarca distintos tamaños, usos, alturas y prestaciones. Originalmente Reverse es una base realizada en polietileno 100% reciclable, sumamente estable y capaz de adaptarse a todo tipo de usos, desde la mesa de reuniones profesional a la mesa en una terraza doméstica o un proyecto de contract. Esta adaptabilidad se ha incrementado con la versión "Occasional", concebida como complemento para sofás y butacas.

Reverse

by Piergiorgio Cazzaniga



▼ **BM 4520 Reverse 38+SB 4572**
Compacto HPL
Polyethylene central base in White
Matte finish and square Compacto
HPL board table. White finish.
Base central de polietileno acabado
en Blanco Mate con sobre cuadrado
Compacto HPL. Acabado Blanco.



**Cafeteria
Cafeteria**
◀ **BM 4520 Reverse 38+SB 4582**

◀ **BM 4562 Reverse 42 (bar height)+SB 4471**
Polyethylene bar height central base in Black Matte finish and round Compact HPL board table. Black finish.
Base central alta en polietileno acabado en Negro Mate con sobre Redondo Compacto HPL. Acabado Negro.

**Cafeteria
Cafeteria**
◀ **BM 4520 Reverse 38+SB 4581 Compacto HPL**
Polyethylene central base in Sand Matte finish and round Compact HPL board table. White finish.
Base central de polietileno acabado en color Arena Mate con sobre redondo Compacto HPL. Acabado Blanco

**Cafeteria
Cafeteria**
▼ **BM 4520 Reverse 38+SB 4581 Compacto HPL**

This table emerges as a complement for the Sand sofas, but its essential line and lightness added to its steel frame, treated for exterior use, allows it to be integrated harmoniously in lounge areas or urban patios. It is stable, durable, and visually discreet. Its structure is available in two finish colors that is combined with technical stone table tops that confer an organic and natural presence.

Esta mesa surge como complemento de los sofás Sand, pero su línea esencial y ligera, sumada a su estructura de acero tratado para exterior le permite integrarse armónicamente en zonas “lounge” o terrazas urbanas. Es estable, resistente y visualmente discreta. Su estructura se presenta en dos acabados de color que se combinan con sobres cerámicos y le confieren una presencia orgánica, matérica y natural.

Sand Table

by Lievore Altherr Molina





Hotel terrace
Terraza Hotel
◀ **ME 4315**

Low table with steel frame and EPL-5 outdoor treatment in Earth Brown finish. Decorative Technical stone table top. Earth Brown finish. Square.

Mesa de centro con estructura de acero y tratamiento EPL-5 en color Marrón Tierra. Sobre de Cerámica decorativa Marrón Tierra. Cuadrada.

▲ **ME 4315**

Low table with Steel Frame and EPL-5 outdoor treatment in White finish. Decorative Technical stone table top. Sand finish. Square.

Mesa de centro con estructura de acero y tratamiento EPL-5 en color Blanco. Sobre de Cerámica Decorativa Arena. Cuadrada.

▲ **ME 4315**

► **ME 4315**

Low table with steel frame and EPL-5 outdoor treatment in Earth Brown finish. Decorative Technical stone table top. Earth Brown finish. Rectangular.

Mesa de centro con estructura de acero y tratamiento EPL-5 en color Marrón Tierra. Sobre de Cerámica decorativa Marrón Tierra. Rectangular.



In all of its versions, Terra is a powerful and remarkable table. It has great versatility of sizes and is an elegant option for a conference room or an eye-catching addition to a waiting area in the form as an occasional table.

Its frame is a cross form, constructed from treated steel for exterior applications, projects a grand personality, combines perfectly with technical stone tops and adapts flawlessly to exterior uses.

En todas sus versiones, Terra es una mesa poderosa y singular. Tiene una gran versatilidad de medidas para dar una respuesta elegante como mesa de reuniones o capturar la mirada en una zona de espera como mesa auxiliar.

Su estructura en forma de cruz –realizada en acero tratado para exterior– le otorga una gran personalidad, combina perfectamente con sobres cerámicos y se adapta perfectamente al uso en exteriores.

Terra

by Lievore Altherr Molina

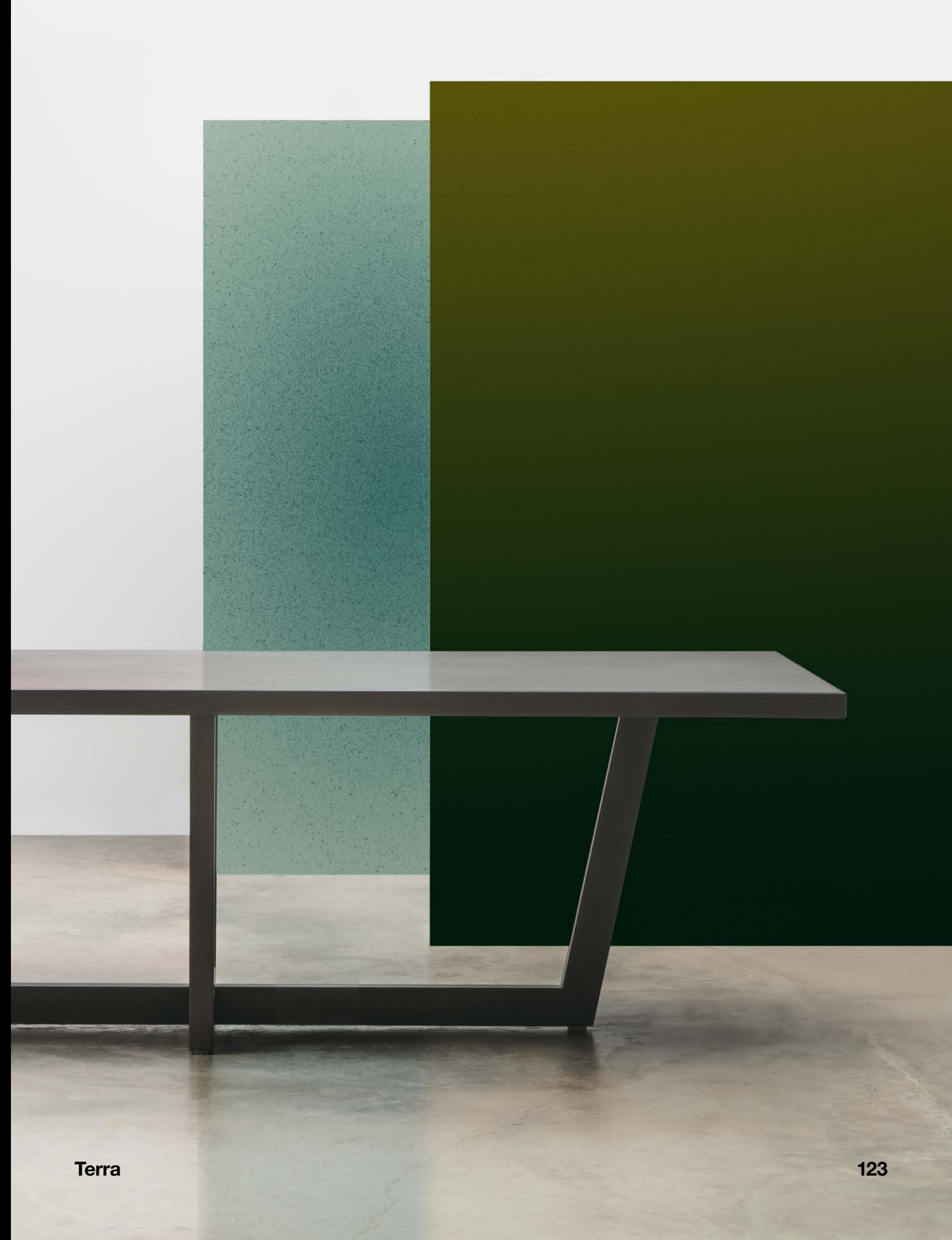



**Home
Hogar**

◀ ME 4692

Table with EPL-5 outdoor treatment in Earth Brown finish and Decorative Technical stone top in Earth Brown.
Mesa con base de acero y tratamiento EPL-5 en Marrón Tierra.
Sobre de Cerámica Decorativa Marrón Tierra.

Terra Occasional

▼ ME 4693

Occasional table with EPL-5 outdoor treatment in Earth Brown finish and Decorative Technical stone top in Stone Grey.
Mesa auxiliar con base de acero y tratamiento EPL-5 en Marrón Tierra.
Sobre de Cerámica Decorativa Gris Piedra.



This collection of tables is highlighted for its versatility of finishes, starting from its durable construction to its visual functionality. Wind is offered in three technical stone and Compact HPL table top sizes and combines impeccably with the Outdoor seating collections.

Este programa de mesas destaca por su versatilidad de acabados a partir de un sistema constructivo resistente y visualmente funcional. Wind se ofrece en tres tamaños de sobre cerámicos o compactos HPL y combina a la perfección con los asientos de la serie Outdoor.

Wind

by Lievore Altherr Molina



Home

Hogar

▼ ME 5895

Table with Technical stone table top in Earth Brown and aluminum legs in Earth Brown finish.

Mesa con sobre de Cerámica Decorativa Marrón Tierra y patas de aluminio en acabado Marrón Tierra.



▼ ME 5896

Table with Technical stone table top in Earth Brown and aluminum legs in Earth Brown finish.

Mesa con sobre de Cerámica Decorativa Marrón Tierra y patas de aluminio en acabado Marrón Tierra.

Home
Hogar

► ME 5896

Table with Technical stone table top in Earth Brown and aluminum legs in Earth Brown finish.

Mesa con sobre de Cerámica Decorativa Marrón Tierra y patas de aluminio en acabado Marrón Tierra.



130

Wind



Wind

131

Technical
information

Información
técnica

Armchair, lounge chair and chaise lounge with reclining backrest with seat and back with aluminum frame and upholstered in Batyline® and steel sled base with EPL5 earth brown or white finish. Chaise lounge is available in wheeled version. Optional auxiliary cushion for the seat and backrest.

Sillón, butaca y tumbona de respaldo reclinable con asiento y respaldo con estructura de aluminio y tapizado en Batyline® y base de patín de acero EPL-5 en acabado blanco o marrón tierra. Disponible versión de tumbona con ruedas. Disponible cojín auxiliar asiento y respaldo.

SO 1280 CJ 1284

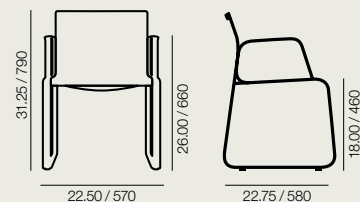

BU 1281 CJ 1285

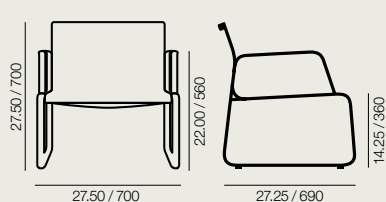

TU 1282 CJ 1286

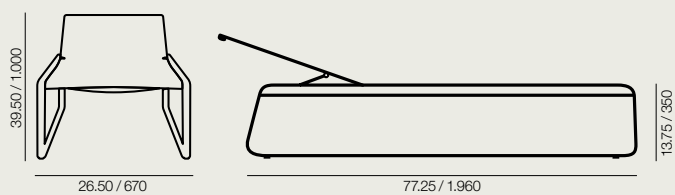

Measurements in./mm.
Medidas in./mm.

SO 1280

Armchair with aluminum frame and seat and back upholstered in Balyline® mesh. Steel sled base with EPL-5 treatment and available in white or brown. Available loose cushion seat and backrest.

Sillón con asiento y respaldo con estructura de aluminio y tapizado en Batyline® y base de patín de acero EPL-5 en acabado blanco o marrón tierra. Disponible cojín auxiliar asiento y respaldo.

BU 1281

Lounge chair with aluminum frame and seat and back upholstered in Balyline® mesh. Steel sled base with EPL-5 treatment and available in white or brown. Available loose cushion seat and backrest.

Butaca con asiento y respaldo con estructura de aluminio y tapizado en Batyline® y base de patín de acero EPL-5 en acabado blanco o marrón tierra. Disponible cojín auxiliar asiento y respaldo.

TU 1282

Chaise lounge with reclining back, aluminum frame and seat and back upholstered in Balyline® mesh. Steel sled base with EPL-5 treatment and available in white or brown. Available loose cushion seat and backrest.

Tumbona de respaldo reclinable con asiento y respaldo con estructura de aluminio y tapizado en Batyline® y base de patín de acero EPL-5 en acabado blanco o marrón tierra. Disponible cojín auxiliar asiento y respaldo.

Steel finish / Acabado de acero

Earth Brown
Marrón Tierra

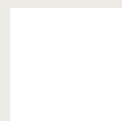

White
Blanco

Batyline® finish / Acabado de Batyline®

Graphite grey
Gris grafito

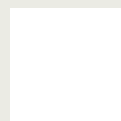

White
Blanco

Certificates / Certificados

EPL-5 Steel UNE CEN/TR 581-4
Acero EPL-5

Durability of exterior-grade furniture
Durabilidad de mobiliario de exterior

SO 1280 + CJ 1284



BU 1281



SO 1280 TU 1282



Folding chair with steel frame and EPL-5 outdoor treatment, available in White or Earth Brown. Woven bands on seat and back are available in several colors.

Silla plegable con estructura de acero y tratamiento EPL-5, disponible en color Blanco o Marrón Tierra. Cincha en asiento y respaldo disponible en varios colores.

SI 0770

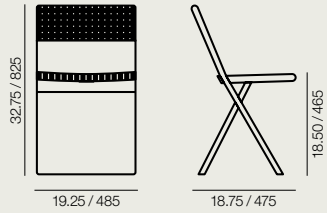

Measurements in./mm.
Medidas in./mm.

SI 0770

Folding chair.
Woven bands
on seat and
back.

Silla plegable.
Cincha en
asiento y
respaldo.

Woven finish / Acabado de cincha

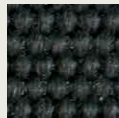

Graphite
Grafito



White
Blanco

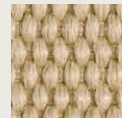

Sand
Arena

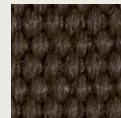

Earth Brown
Marrón Tierra

Steel finish / Acabado de acero



Earth Brown
Marrón Tierra

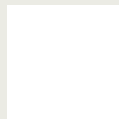

White
Blanco

Certificates / Certificados

EPL-5 Steel UNE CEN/TR 581-4 Durability of exterior-grade furniture
Acero EPL-5 Durabilidad de mobiliario de exterior

Woven band ISO 105-B02, ISO 105-X12, ISO 105-E03
Cincha

SI 0770



SI 0770



Chairs and armchairs with thermoplastic seat and back available in 7 different colors and bases of 4 steel tubes or steel sled with titanium, white or earth brown finish.

Sillas y sillones con asiento y respaldo de termopolímero disponible en 7 colores diferentes y bases de 4 patas de tubo de acero o patín de varilla de acero y acabado titanio, blanco o marrón tierra.

SI 1320

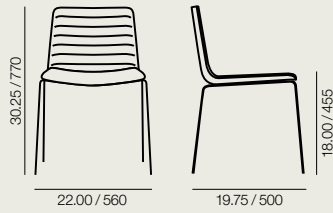

SO 1321

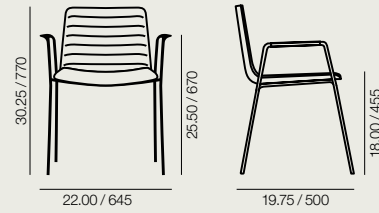

BQ 1328

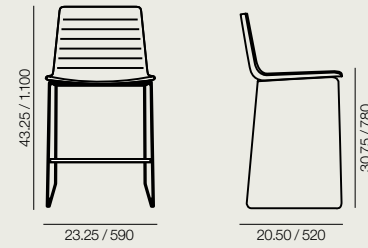

SI 1322

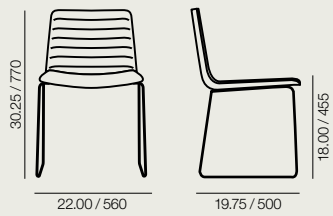

SO 1323

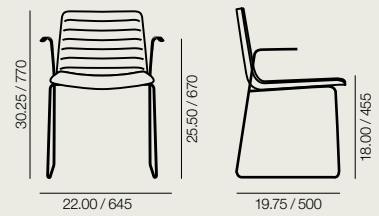

Measurements in./mm.
Medidas in./mm.

SI 1320

Outdoor stackable chair with thermo-polymer shell and 4 steel legs finished in titanium, white or earth brown.

Silla con asiento y respaldo de termopolímero y base de 4 patas de tubo de acero en acabado en titanio, blanco o marrón tierra.

SO 1321

Outdoor stackable armchair with thermo-polymer shell and 4 steel legs finished in titanium, white or earth brown.

Sillón con asiento y respaldo de termopolímero y base de 4 patas de tubo de acero en acabado en titanio, blanco o marrón tierra.

SI 1322

Outdoor stackable chair with thermo-polymer shell and sled base finished in titanium, white or earth brown.

Silla con asiento y respaldo de termopolímero y base de varilla de patín de acero en acabado en titanio, blanco o marrón tierra.

SO 1323

Outdoor stackable armchair with thermo-polymer shell and sled base finished in titanium, white or earth brown.

Silla con asiento y respaldo de termopolímero y base de varilla de patín de acero en acabado en titanio, blanco o marrón tierra.

BQ 1328

Outdoor barstool with thermo-polymer shell and sled base finished in titanium, white or earth brown.

Banqueta con asiento y respaldo de termopolímero y base de varilla de patín de acero en acabado en titanio, blanco o marrón tierra.



SI 1322



SO 1323 SI 1320 SI 1322



Thermo-polymer finish / Acabado de termopolímero

						
6000 RAL 9003 White Blanco	6002 NCS2005-Y20R Sand Arena	6012 NCS S 4005-Y20R Basalt Grey Gris Basalto	6003 RAL 3013 Cayenne Red Rojo Cayena	6006 RAL 9005 Black Negro	6013 NCS S 6502-B Dark Grey Gris Oscuro	6014 NCS S 3050-G60Y Mango Green Verde Mango

Steel finish / Acabado de acero

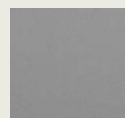
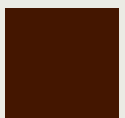
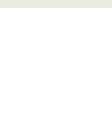
		
Titanium Titanio	Earth Brown Marron Tierra	White Blanco

Certificates / Certificados

EPL-5 Steel UNE CEN/TR 581-4 Durability of exterior-grade furniture
 Acero EPL-5 Durabilidad de mobiliario de exterior

SI 1322

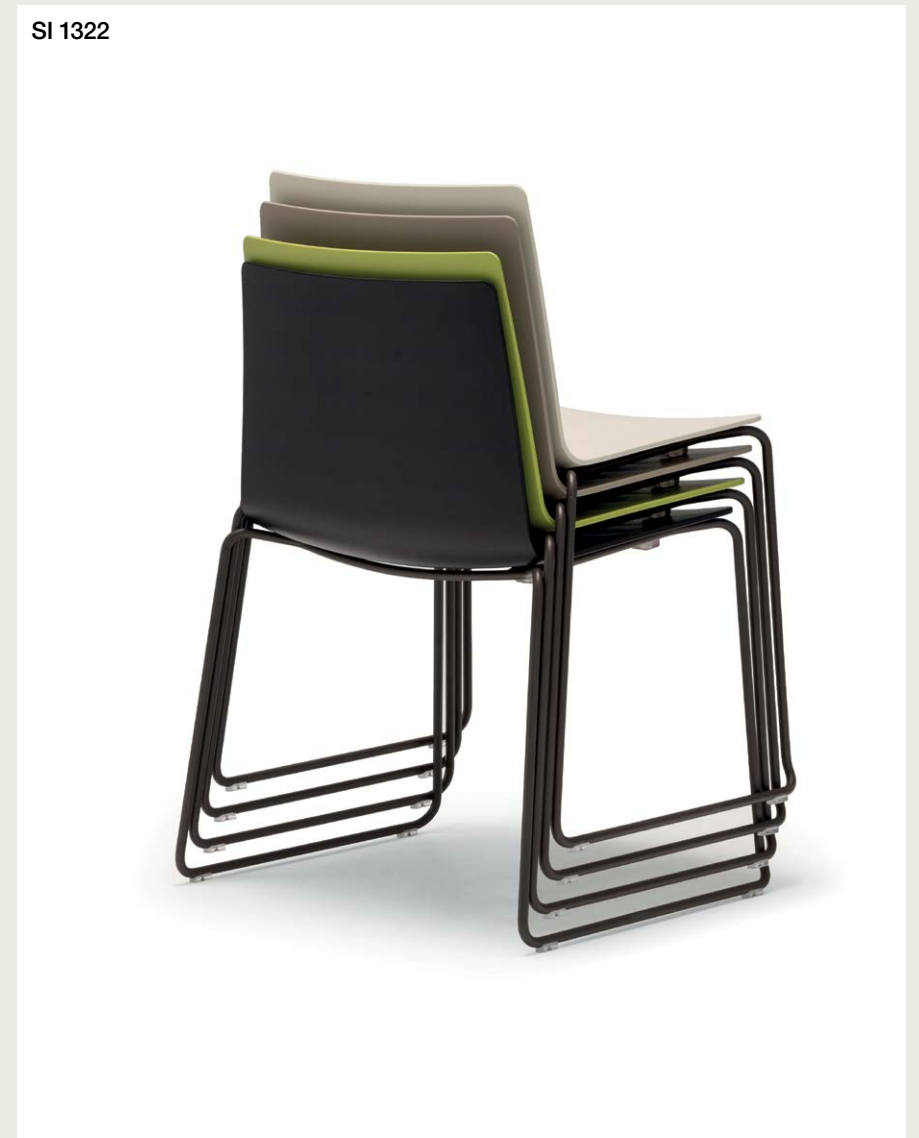

BQ 1328



SI 1320



Collection of two and three-seater sofas with or without armrests. The aluminum frame is available in Earth Brown. Adjustable reclining chaise lounge available.

Colección de sofás de dos y tres plazas, con y sin brazos y tumbona de inclinación regulable disponibles con estructura de aluminio en color Marrón Tierra.

SF 4630

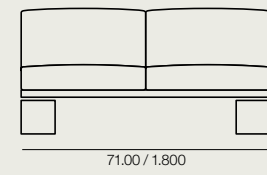
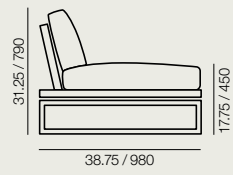

SF 4632

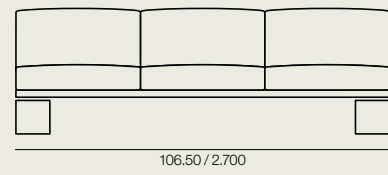

SF 4631

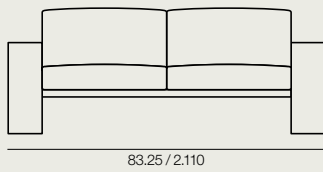
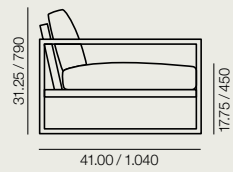

SF 4633

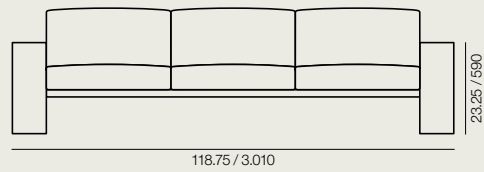

SF 4634

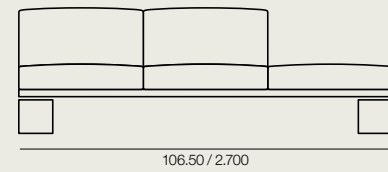
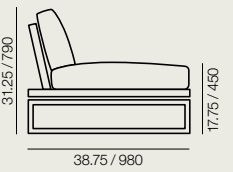

SF 4635

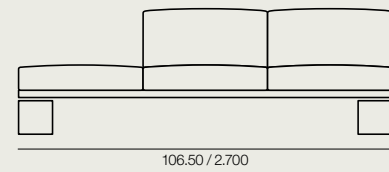

SF 4636

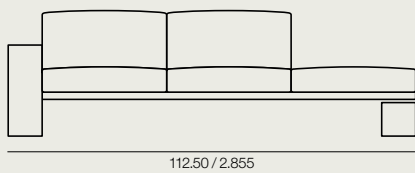
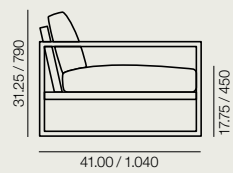

SF 4637

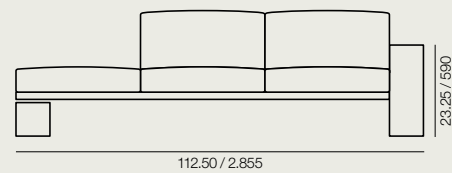

Measurements in./mm.
Medidas in./mm.

SF 4630	SF 4631	SF 4632	SF 4633	SF 4634	SF 4635	SF 4636	SF 4637	TU 4638
Armless sofa. 2-seater.	Sofa with two arms. 2-seater.	Armless sofa. 3-seater.	Sofa with two arms. 3-seater.	Armless sofa. 3-seater. Two seats with backs and one backless.	Armless sofa. 3-seater. Two seats with backs and one backless.	Sofa with single arms. 3-seater. Two seats with backs and one backless.	Sofa with single arms. 3-seater. Two seats with backs and one backless.	Chaise lounge with wheels. Reclining back.
Sofá sin brazos. 2 plazas.	Sofá con brazos. 2 plazas.	Sofá sin brazos. 3 plazas.	Sofá con brazos. 3 plazas.	Sofá sin brazos. 3 plazas. Dos asientos con respaldo y uno sin respaldo.	Sofá sin brazos. 3 plazas. Dos asientos con respaldo y uno sin respaldo.	Sofá con un brazo. 3 plazas. Dos asientos con respaldo y uno sin respaldo.	Sofá con un brazo. 3 plazas. Dos asientos con respaldo y uno sin respaldo.	Tumbona con ruedas. Respaldo reclinable.
FU 4801	FU 4801	FU 4802	FU 4802	FU 4802	FU 4802	FU 4802	FU 4802	FU 4806

TU 4638

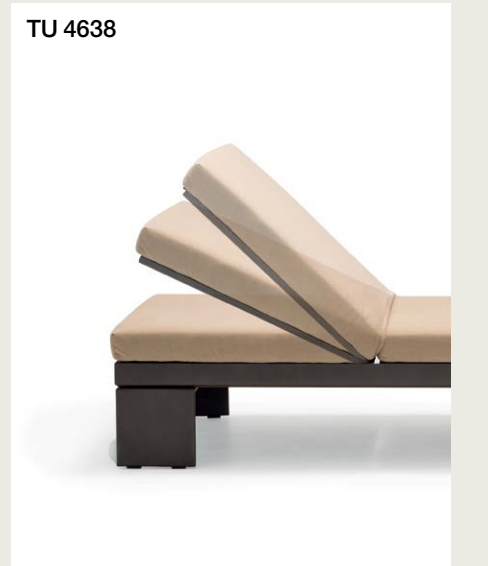

TU 4638

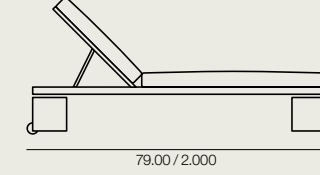
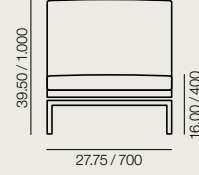

TU 4638



Upholstery / Tapicería

Andreu World collections use various types of upholstery in acrylic and faux leather that are especially designed for outdoor use. The covers and cushions are made of waterproof polyester fabric to protect the furniture from moisture, rain, and sun. For fabrics not specified in this box, contact our Customer Department.

En las colecciones de Andreu World Outdoor se han utilizado distintos tipos de tapicerías de fibra acrílica y ecopiel, especialmente concebidas para su uso en exterior. Las fundas y cojines están confeccionados con un tejido impermeable de poliéster que protegen el mobiliario de la humedad, lluvia y el sol. Para otros tejidos no reflejados en este cuadro consultar con el Departamento Comercial.

Sand	Grade 1	5 colors/colores	Pag. 204
Solids&Stripes	Grade 2	14 colors/colores	Pag. 205
Silvertex	Grade 2	15 colors/colores	Pag. 206
Natte	Grade 3	9 colors/colores	Pag. 207
Chartres	Grade 6	13 colors/colores	Pag. 208
Lopi	Grade 8	15 colors/colores	Pag. 209

Aluminum finish / Acabado de aluminio



Earth Brown
Marrón Tierra

Extra cushion / Cojín auxiliar

CJ 4610

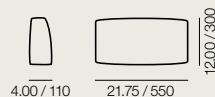

CJ 4700



CJ 4701

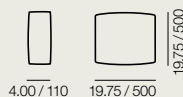

Certificates / Certificados

Fabric cushion	Waterproof, breathable, antibacterial + antifungal	British Standard
Tejido del cojín	Impermeable, transpirable, antibacterias + antihongos	BS7175 Crib 5

Aluminum	UNE CEN/TR 581-4
Aluminio	

SF 4633



SF 4636



SF 4636



Stackable side chair collection with thermo-polymer seat and back.
Available in several colors.

Silla apilable con asiento y respaldo en termopolímero. Disponible en diferentes colores.

SI 1245

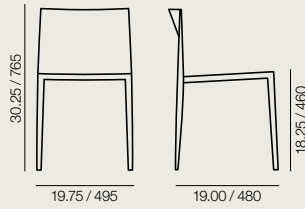

Measurements in./mm.
Medidas in./mm.

SI 1245

Chair, thermo-polymer seat and back.
Minimum order per color: 6 units.
Stackability: 12 units on floor. 15 units on trolley.

Silla con asiento y respaldo en termopolímero. Pedido mínimo por color: 6 unidades.
Apilabilidad: 12 unidades sobre suelo. 15 unidades en carro.

Thermo-polymer finish / Acabado de termopolímero

						
6000 RAL 9003 White Blanco	6002 NCS2005-Y20R Sand Arena	6012 NCS S 4005-Y20R Basalt Grey Gris Basalto	6003 RAL 3013 Cayenne Red Rojo Cayena	6006 RAL 9005 Black Negro	6013 NCS S 6502-B Dark Grey Gris Oscuro	6014 NCS S 3050-G60Y Mango Green Verde Mango

Certificates / Certificados

Structural durability tests
Ensayos de durabilidad estructural

European Standards:
UNE EN 15373:07 (Level 3)

SI 1245



SI 1245



SI 1245



SI 1245



The Sand collection includes three-seater sofas with woven band backrest and arms and is available in Earth Brown, Sand, Graphite or White finish. Available with upholstered cushions for seat and backrest, and the steel frame has received the EPL-5 outdoor treatment in either White or Earth Brown finish.

Colección de sofás de tres plazas con respaldo y brazos cinchado con cinchas en acabado Marrón Tierra, Arena, Grafito o Blanco, cojines tapizados en asiento y respaldo y estructura de acero con tratamiento EPL-5 para exterior en acabado Blanco o Marrón Tierra.

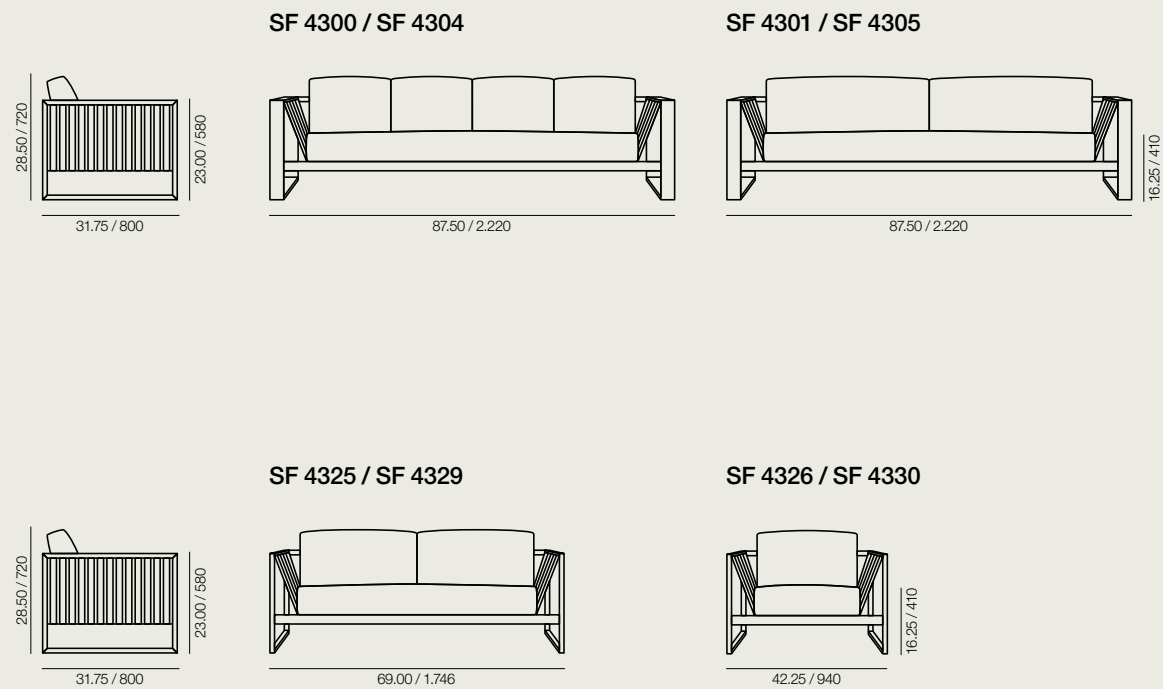

Measurements in./mm.
 Medidas in./mm.

SF 4300	SF 4301	SF 4325	SF 4326	SF 4304	SF 4305	SF 4329	SF 4330
Steel frame in White. 3-seater. Woven bands on back and arms.	Steel frame in White. 3-seater. Woven bands on back and arms.	Steel frame in White. 2-seater. Woven bands on back and arms.	Steel frame in White. 1-seater. Woven bands on back and arms.	Steel frame in Earth Brown. 3-seater. Woven bands on back and arms.	Steel frame in Earth Brown. 3-seater. Woven bands on back and arms.	Steel frame in Earth Brown. 2-seater. Woven bands on back and arms.	Steel frame in Earth Brown. 1-seater. Woven bands on back and arms.
Estructura de acero en color Blanco. 3 plazas. Cincha en respaldo y brazos.	Estructura de acero en color Blanco. 3 plazas. Cincha en respaldo y brazos.	Estructura de acero en color Blanco. 2 plazas. Cincha en respaldo y brazos.	Estructura de acero en color Blanco. 1 plaza. Cincha en respaldo y brazos.	Estructura de acero en color Marrón Tierra. 3 plazas. Cincha en respaldo y brazos.	Estructura de acero en color Marrón Tierra. 3 plazas. Cincha en respaldo y brazos.	Estructura de acero en color Marrón Tierra. 2 plazas. Cincha en respaldo y brazos.	Estructura de acero en color Marrón Tierra. 1 plazas. Cincha en respaldo y brazos.
FU 4800	FU 4800	FU 4807	FU 4808	FU 4800	FU 4800	FU 4807	FU 4808

SF 4300



SF 4330



SF 4301



SF 4326



Upholstery / Tapicería

Andreu World collections use various types of upholstery in acrylic and faux leather that are especially designed for outdoor use. The covers and cushions are made of waterproof polyester fabric to protect the furniture from moisture, rain, and sun. For fabrics not specified in this box, contact our Customer Department.

En las colecciones de Andreu World Outdoor se han utilizado distintos tipos de tapicerías de fibra acrílica y ecopiel, especialmente concebidas para su uso en exterior. Las fundas y cojines están confeccionados con un tejido impermeable de poliéster que protegen el mobiliario de la humedad, lluvia y el sol. Para otros tejidos no reflejados en este cuadro consultar con el Departamento Comercial.

Sand	Grade 1	5 colors/colores	Pag. 204
Solids&Stripes	Grade 2	14 colors/colores	Pag. 205
Silvertex	Grade 2	15 colors/colores	Pag. 206
Natte	Grade 3	9 colors/colores	Pag. 207
Chartres	Grade 6	13 colors/colores	Pag. 208
Lopi	Grade 8	15 colors/colores	Pag. 209

Woven finish / Acabado de cincha

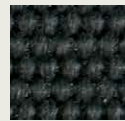

Graphite
Grafito



White
Blanco

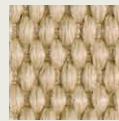

Sand
Arena

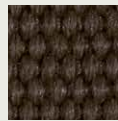

Earth Brown
Marrón Tierra

Steel finish / Acabado de acero



Earth Brown
Marrón Tierra

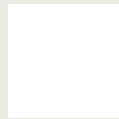

White
Blanco

Extra cushion / Cojín auxiliar

CJ 4314

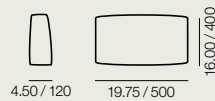

CJ 4700



CJ 4701

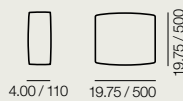

Certificates / Certificados

EPL-5 Steel
Acero EPL-5

UNE CEN/TR 581-4
Durability of exterior-grade furniture
Durabilidad de mobiliario de exterior

Woven band
Cincha

ISO 105-B02, ISO 105-X12, ISO 105-E03

Fabric cushion
Tejido del cojín

Waterproof, breathable, antibacterial + antigungal
Impermeable, transpirable, antibacterias + antihongos

British Standard
BS7175 Crib 5

SF 4304



SF 4304



SF 4301



Chairs, armchairs and lounge chairs with braided strap seat and back in earth brown, sand, graphite or white nish and teak wood frame suitable for exterior use. Also available in footrest version.

Sillas, sillones y butacas con asiento y respaldo cinchado con cinchas en acabado marrón tierra, arena, grafito o blanco y estructura de madera maciza de teca, válida para uso en exterior. Disponible versión de reposapiés.

SI 1190

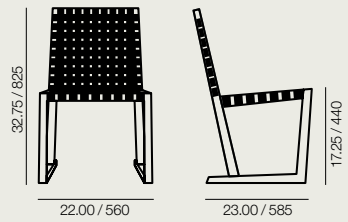

SO 1191

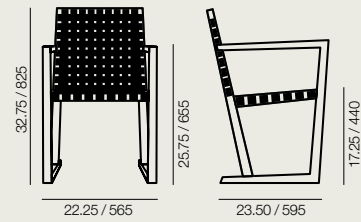

BU 1192

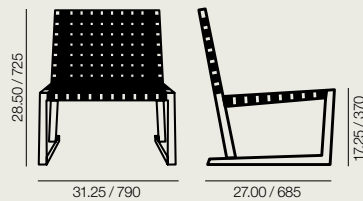

BU 1193

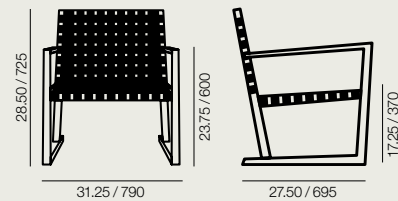

RS 1196

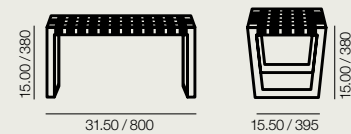

BU 1194

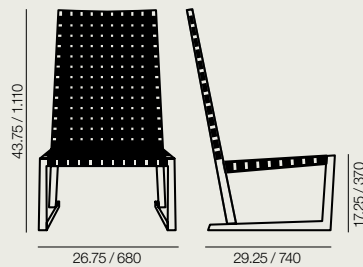

BU 1195

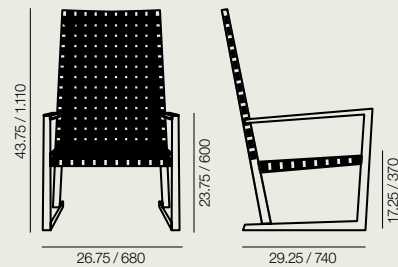

Measurements in./mm.
Medidas in./mm.

SI 1190

Chair with webbing seat and backrest and solid teak wood frame.

Silla con asiento y respaldo cinchado y estructura de madera maciza de teca.

SO 1191

Armchair with webbing seat and backrest and solid teak wood frame.

Sillón con asiento y respaldo cinchado y estructura de madera maciza de teca.

BU 1192

Lounge chair with webbing seat and backrest and solid teak wood frame. Low back version.

Butaca de respaldo bajo con asiento y respaldo cinchado y estructura de madera maciza de teca.

CJ 1180
CJ 1181

BU 1193

Lounge arm chair with webbing seat and backrest and solid teak wood frame. Low back version.

Butaca de respaldo bajo con brazos, asiento y respaldo cinchado y estructura de madera maciza de teca.

CJ 1180
CJ 1188

RS 1196

Ottoman with webbing seat and solid teak wood frame.

Reposapiés con asiento cinchado y estructura de madera maciza de teca.

BU 1194

Lounge chair with webbing seat and backrest and solid teak wood frame. High back version.

Butaca de respaldo alto con asiento y respaldo cinchado y estructura de madera maciza de teca.

CJ 1178
CJ 1179

BU 1195

Lounge arm chair with webbing seat and backrest and solid teak wood frame. High back version.

Butaca de respaldo alto con brazos, asiento y respaldo cinchado y estructura de madera maciza de teca.

CJ1178
CJ1187

SO 1191



SI 1190



BU 1195 + RS 1196



Chairs, armchairs and lounge chairs with braided strap seat and back in earth brown, sand, graphite or white nish and teak wood frame suitable for exterior use. Also available in footrest version.

Sillas, sillones y butacas con asiento y respaldo cinchado con cinchas en acabado marrón tierra, arena, grafito o blanco y estructura de madera maciza de teca, válida para uso en exterior. Disponible versión de reposapiés.

Woven finish / Acabado de cincha



Graphite
Grafito



White
Blanco

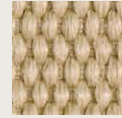

Sand
Arena



Earth Brown
Marrón Tierra

Wood finish / Acabado de madera

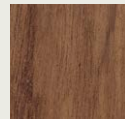

329

Extra cushion / Cojín auxiliar

CJ 1177

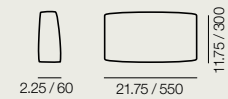

CJ 1178

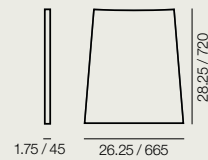

CJ 1179

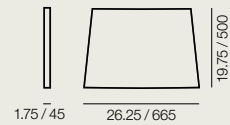

CJ 1180

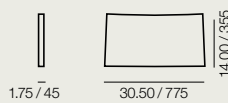

CJ 1181

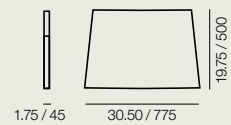

CJ 1187

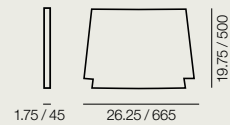

CJ 1188

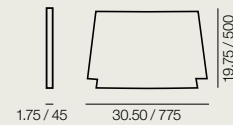

Certificates / Certificados

Woven band ISO 105-B02, ISO 105-X12, ISO 105-E03
Cincha

Fabric cushion Waterproof, breathable, antibacterial + antigungal British Standard
Tejido del cojín Impermeable, transpirable, antibacterias + anihongos BS7175 Crib 5

BU 1193



BU 1194 SI 1190 SO 1191



Highly modular sectional sofa that allows for numerous configurations. Constructed with an EPL-5 treated steel structure and finished in White or Earth Brown. Removable upholstered parts are available in all our outdoor fabrics.

Sofá componible de gran modularidad, que permite diferentes composiciones. Estructura de acero con tratamiento EPL-5 acabada en Blanco o Marrón Tierra y partes tapizadas desmontables, disponibles en todos nuestros tejidos para uso exterior.

SF 4750

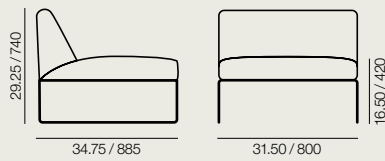

SF 4751

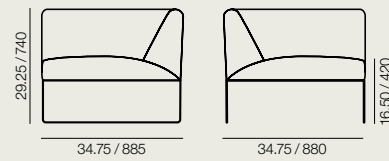

SF 4755

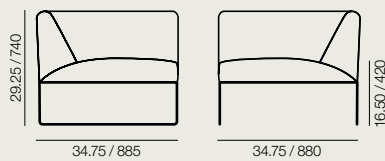

RS 4754

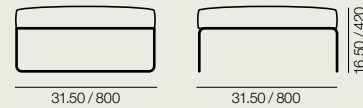

Measurements in./mm.
Medidas in./mm.

SF 4750	SF 4751	SF 4755	RS 4754
Central sofa module.	Right corner sofa module.	Left corner sofa module.	Ottoman.
Módulo central.	Módulo rinconero. Lado derecho.	Módulo rinconero. Lado izquierdo.	Reposapiés.
FU 4760 FU 4763 FU 4764	FU 4761 FU 4763 FU 4764	FU 4761 FU 4763 FU 4764	FU 4765

Examples of modular configurations / Ejemplos de combinaciones modulares

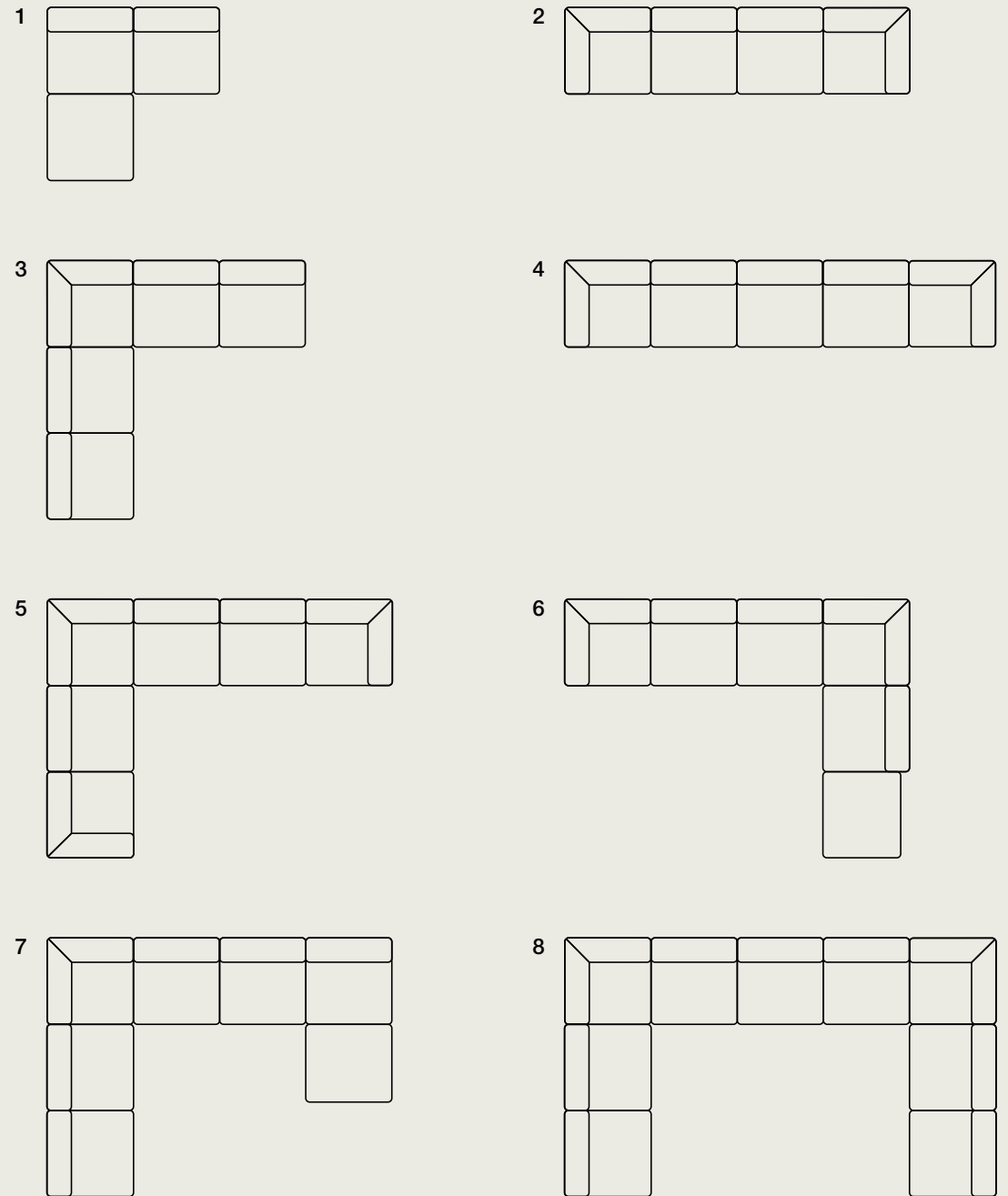

This system allows for numerous configurations by combining various modules, ottomans and side tables of the Siesta collection. Este sistema permite más composiciones combinando los diferentes módulos, reposapiés y mesa auxiliar de la colección Siesta entre sí.

1	2	3	4	5	6	7	8
RS 4754 SF 4750 x 2	SF 4755 SF 4750 x 2 SF 4751	SF 4750 x 2 SF 4755 SF 4750 x 2	SF 4755 SF 4750 x 3 SF 4751	SF 4755 SF 4750 SF 4755 SF 4750 x 2 SF 4751	SF 4755 SF 4750 x 2 SF 4751 SF 4750 RS 4754	SF 4750 x 2 SF 4755 SF 4750 x 3 RS 4754	SF 4750 x 2 SF 4755 SF 4750 x 3 SF 4751 SF 4750 x 2

Upholstery / Tapicería

Andreu World collections use various types of upholstery in acrylic and faux leather that are especially designed for outdoor use. The covers and cushions are made of waterproof polyester fabric to protect the furniture from moisture, rain, and sun. For fabrics not specified in this box, contact our Customer Department.

En las colecciones de Andreu World Outdoor se han utilizado distintos tipos de tapicerías de fibra acrílica y ecopiel, especialmente concebidas para su uso en exterior. Las fundas y cojines están confeccionados con un tejido impermeable de poliéster que protegen el mobiliario de la humedad, lluvia y el sol. Para otros tejidos no reflejados en este cuadro consultar con el Departamento Comercial.

Sand	Grade 1	5 colors/colores	Pag. 204
Solids&Stripes	Grade 2	14 colors/colores	Pag. 205
Silvertex	Grade 2	15 colors/colores	Pag. 206
Natte	Grade 3	9 colors/colores	Pag. 207
Chartres	Grade 6	13 colors/colores	Pag. 208
Lopi	Grade 8	15 colors/colores	Pag. 209

Steel finish / Acabado de acero



Earth Brown
Marrón Tierra

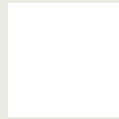

White
Blanco

Certificates / Certificados

EPL-5 Steel UNE CEN/TR 581-4
Acero EPL-5

Durability of exterior-grade furniture
Durabilidad de mobiliario de exterior

Fabric cushion Waterproof, breathable, antibacterial + antigungal
Tejido del cojín Impermeable, transpirable, antibacterias + antihongos

British Standard
BS7175 Crib 5

SF 4755



SF 4750 + RS 4754



SF 4755 + SF 4750 x 2 + SF 4751 + SF 4750 + RS 4754 + ME 4753



SF 4755 + SF 4750 + SF 4751



Collection of chairs and armchairs suitable for outdoor use. Constructed with thermo-polymer seats and backs and is available in 6 colors. Base options include 4-legged frame and steel sled base with EPL-5 treatment, available in titanium.

Colección de sillas y sillón válidos para exterior con asiento y respaldo de termopolímero en 6 colores. Disponible con estructura de cuatro patas y patín de acero con tratamiento EPL-5 y acabado titanio.

SI 1235

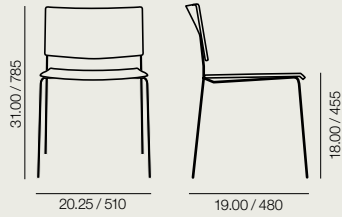

SO 1236

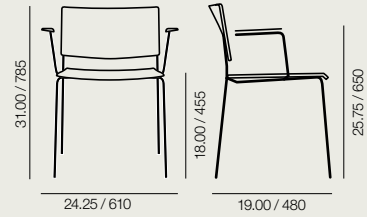

SI 1237

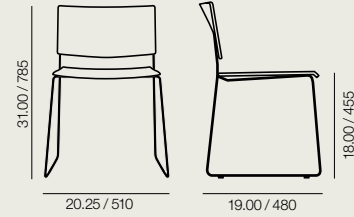

BQ 1238

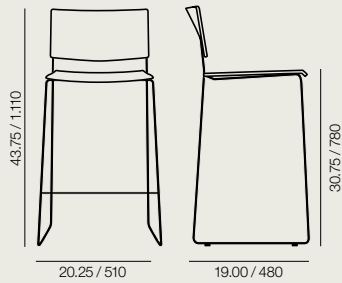

BQ 1239

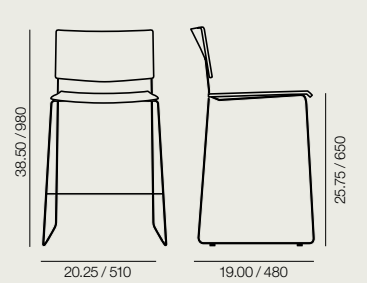

Measurements in./mm.
Medidas in./mm.

SI 1235

Chair.
4-legged steel tubular frame.

Silla.
Estructura 4 patas de tubo de acero.

SO 1236

Armchair.
4-legged steel tubular frame.

Sillón.
Estructura 4 patas de tubo de acero.

SI 1237

Chair.
Steel sled base.

Silla.
Estructura patín de varilla de acero.

BQ 1238

Barstool.
Steel sled base.

Banqueta alta.
Estructura patín de varilla de acero.

BQ 1239

Counter stool.
Steel sled base.

Banqueta baja.
Estructura patín de varilla de acero.

Thermo-polymer finish / Acabado de termopolímero



6000
RAL 9003
White
Blanco

6002
NCS2005-Y20R
Sand
Arena

6012
NCS S 4005-Y20R
Basalt Grey
Gris Basalto

6003
RAL 3013
Cayenne Red
Rojo Cayena

6006
RAL 9005
Black
Negro

6013
NCS S 6502-B
Dark Grey
Gris Oscuro

SI 1237



SI 1235



BQ 1239 BQ 1238



Steel finish / Acabado de acero

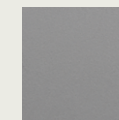

Titanium
Titanio

Certificates / Certificados

EPL-5 Steel
Acero EPL-5

UNE CEN/TR 581-4

Durability of exterior-grade furniture
Durabilidad de mobiliario de exterior

Collection of chairs, lounge chairs, and barstool with woven band seats and backs available in Earth Brown, Sand, Graphite and White. Chaise lounge version with a headrest cushion is available. The steel EPL-5 outdoor treated frame is finished in White or Earth Brown.

Programa de sillas, butacas y taburetes con cincha en asiento y respaldo disponible en color Marrón Tierra, Arena, Grafito y Blanco. Se ofrece una chaise lounge y un cojín reposacabezas. Su estructura de acero con tratamiento EPL-5 está acabada en color Blanco o Marrón Tierra.

SI 0700

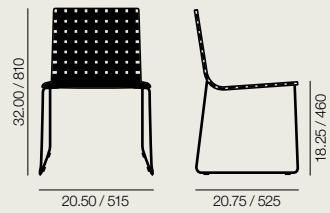

SO 0701

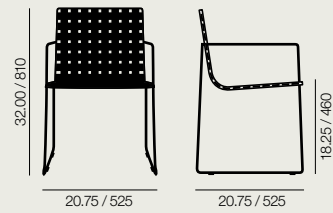

BQ 0705

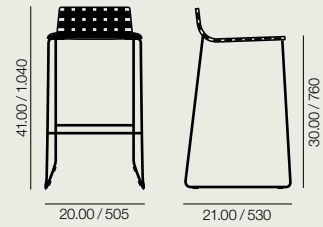

BU 0702

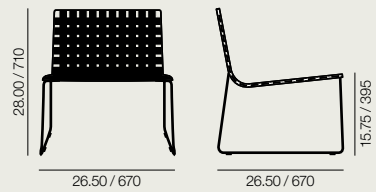

BU 0703

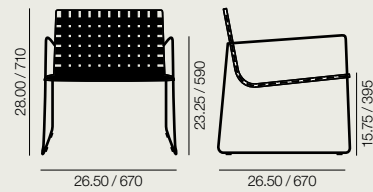

TU 0704

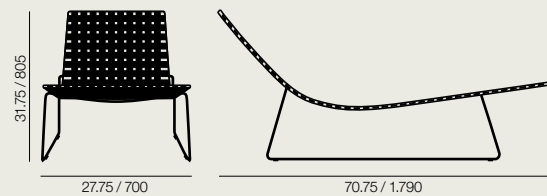

Measurements in./mm.
Medidas in./mm.

SI 0700

Chair with steel sled frame.

Silla de patín.

SO 0701

Armchair with steel sled frame.

Sillón de patín.

BQ 0705

Barstool with steel sled frame.

Banqueta de patín con estructura de acero.

BU 0702

Lounge chair with steel sled frame.

Butaca de patín con estructura de acero.

BU 0703

Lounge chair with arms and steel sled frame.

Butaca de patín con brazos y estructura de acero.

TU 0704

Chaise lounge with steel sled frame.

Tumbona de patín con estructura de acero.

SI 0700



BQ 0705



SO 0701



SI 0700



Upholstery / Tapicería

Andreu World collections use various types of upholstery in acrylic and faux leather that are especially designed for outdoor use. The covers and cushions are made of waterproof polyester fabric to protect the furniture from moisture, rain, and sun. For fabrics not specified in this box, contact our Customer Department.

En las colecciones de Andreu World Outdoor se han utilizado distintos tipos de tapicerías de fibra acrílica y ecopiel, especialmente concebidas para su uso en exterior. Las fundas y cojines están confeccionados con un tejido impermeable de poliéster que protegen el mobiliario de la humedad, lluvia y el sol. Para otros tejidos no reflejados en este cuadro consultar con el Departamento Comercial.

Sand	Grade 1	5 colors/colores	Pag. 206
Solids&Stripes	Grade 2	14 colors/colores	Pag. 207
Silvertex	Grade 2	15 colors/colores	Pag. 208
Natte	Grade 3	9 colors/colores	Pag. 209
Chartres	Grade 6	13 colors/colores	Pag. 210
Lopi	Grade 8	15 colors/colores	Pag. 211

Woven finish / Acabado de cincha



Graphite
Grafito



White
Blanco

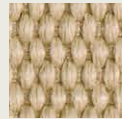

Sand
Arena



Earth Brown
Marrón Tierra

Steel finish / Acabado de acero



Earth Brown
Marrón Tierra

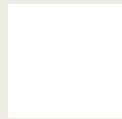

White
Blanco

Headrest cushion / Cojín reposacabezas

CJ 0706



Ø4.75 / 120 20.25 / 520

Certificates / Certificados

EPL-5 Steel UNE CEN/TR 581-4 Durability of exterior-grade furniture
Acero EPL-5 Durabilidad de mobiliario de exterior

Woven band ISO 105-B02, ISO 105-X12, ISO 105-E03
Cincha

BU 0702



BU 0703



TU 0704



Injection aluminum table base with an oval column and rounded baseplate. Available in 3 different diameters and 4 heights. Offered in polished Earth Brown, White or Matte Black. Combinable with any model from our outdoor Top Collections.

Base de mesa con pie circular y columna ovalada de inyección de aluminio. Disponible en 3 diámetros y 4 alturas diferentes. Se ofrece en acabados Marrón Tierra, Blanco o Negro Mate. Combinable con cualquier modelo de las colecciones Top de Andreu World outdoor.

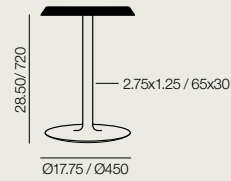

Maximum table top
27.50x27.50 / Ø27.50

Medida máxima de sobre
700x700 / Ø700

BM 4361
Earth Brown
Marrón Tierra

Aluminum finish
Acabado aluminio

Aluminum finish
Acabado aluminio

Aluminum finish
Acabado aluminio

White
Blanco

Matte Black
Negro Mate

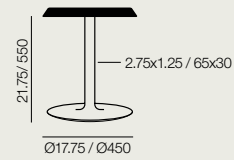

Maximum table top
31.50x31.50 / Ø31.50

Medida máxima de sobre
800x800 / Ø800

BM 4364
Earth Brown
Marrón Tierra

White
Blanco

Matte Black
Negro Mate



Maximum table top
31.50x31.50 / Ø31.50

Medida máxima de sobre
800x800 / Ø800

BM 4367
Earth Brown
Marrón Tierra

White
Blanco

Matte Black
Negro Mate

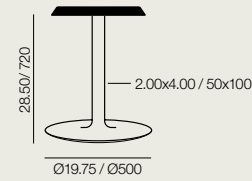

Maximum table top
39.50x39.50 / Ø39.50

Medida máxima de sobre
1.000x1.000 / Ø1.000

BM 4386
Earth Brown
Marrón Tierra

White
Blanco

Matte Black
Negro Mate

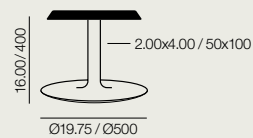

Maximum table top
39.50x39.50 / Ø39.50

Medida máxima de sobre
1.000x1.000 / Ø1.000

BM 4384
Earth Brown
Marrón Tierra

Aluminum finish
Acabado aluminio

Aluminum finish
Acabado aluminio

Aluminum finish
Acabado aluminio

White
Blanco

Matte Black
Negro Mate

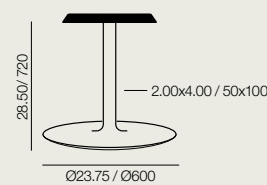

Maximum table top
47.25x47.25 / Ø47.25

Medida máxima de sobre
1.200x1.200 / Ø1.200

BM 4380
Earth Brown
Marrón Tierra

White
Blanco

Matte Black
Negro Mate

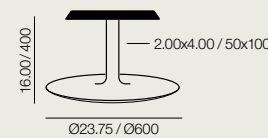

Maximum table top
47.25x47.25 / Ø47.25

Medida máxima de sobre
1.200x1.200 / Ø1.200

BM 4378
Earth Brown
Marrón Tierra

White
Blanco

Matte Black
Negro Mate

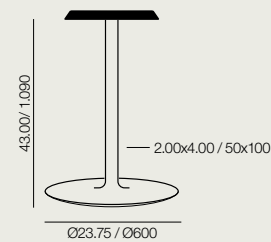

Maximum table top
35.50x35.50 / Ø35.50

Medida máxima de sobre
900x900 / Ø900

BM 4382
Earth Brown
Marrón Tierra

White
Blanco

Matte Black
Negro Mate

Table. Injection aluminum table base with an oval column and rounded base plate. Available in 2 heights and offered in Earth Brown, White or Matte Black with Technical stone or solid core high pressure laminate top (HPL).

Mesa con pie circular y columna ovalada de inyección de aluminio. Disponible en 2 alturas. Se ofrece en acabados Marrón Tierra, Blanco o Negro Mate y sobres Cerámicos o Compacto laminado de alta presión (HPL).

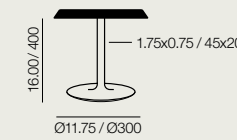

Top measures
15.75x15.75

Medida sobre
400x400

Table top
Sobre
Compacto HPL

Aluminum finish
Acabado aluminio

Aluminum finish
Acabado aluminio

Aluminum finish
Acabado aluminio

ME 6425
Earth Brown
Marrón Tierra

White
Blanco

Matte Black
Negro Mate

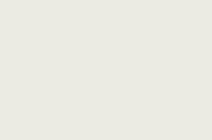

Top measures ellipse
15.75x15.75

Medida sobre elipse
400x400

Table top
Sobre
Compacto HPL

ME 6430
Earth Brown
Marrón Tierra

White
Blanco

Matte Black
Negro Mate

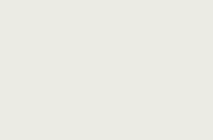

Top measures
Ø17.75

Medida sobre
Ø450

Table top
Sobre
Compacto HPL

ME 6435
Earth Brown
Marrón Tierra

White
Blanco

Matte Black
Negro Mate

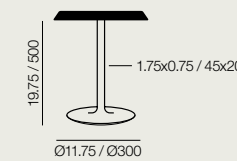

Top measures
15.75x15.75

Medida sobre
400x400

Table top
Sobre
Compacto HPL

Aluminum finish
Acabado aluminio

Aluminum finish
Acabado aluminio

Aluminum finish
Acabado aluminio

ME 6440
Earth Brown
Marrón Tierra

White
Blanco

Matte Black
Negro Mate

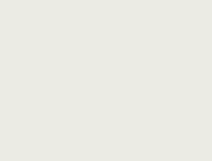

Top measures ellipse
15.75x15.75

Medida sobre elipse
400x400

Table top
Sobre
Compacto HPL

ME 6445
Earth Brown
Marrón Tierra

White
Blanco

Matte Black
Negro Mate

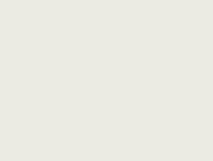

Top measures
Ø17.75

Medida sobre
Ø450

Table top
Sobre
Compacto HPL

ME 6450
Earth Brown
Marrón Tierra

White
Blanco

Matte Black
Negro Mate

Aluminum finish / Acabado de aluminio

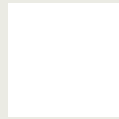
Earth Brown
Marrón TierraWhite
BlancoMatte Black
Negro Mate

Certificates / Certificados

Aluminum
Aluminio

UNE CEN/TR 581-4

Durability of exterior-grade furniture
Durabilidad de mobiliario de exterior

Dual Occasional

Aluminum finish / Acabado de aluminio

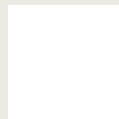
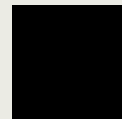
Earth Brown
Marrón TierraWhite
BlancoMatte Black
Negro Mate

Compact HPL finish / Acabado Compact HPL

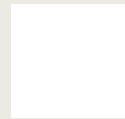
White
BlancoMatte Black
Negro Mate

Technical stone decorative finish / Acabado cerámica decorativa

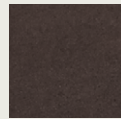
Earth Brown
Marrón TierraSand Grey
Gris ArenaStone Grey
Gris Piedra

Certificates / Certificados

Aluminum
Aluminio

UNE CEN/TR 581-4

Durability of exterior-grade furniture
Durabilidad de mobiliario de exteriorCompacto
EN 438-6, EN 4382-2-10, EN 4382-2-12, EN 4382-2-14,
EN 4382-2-16, EN 4382-2-17, EN 4382-2-21,
EN 4382-2-24, EN 4382-2-25, EN 4382-2-26,
EN 4382-2-27, EN 4382-2-30, EN 12721European Standard
UNE EN 13501

BM 4361



BM 4364 / BM 4361

Dual Occasional
ME 6435
ME 6450

Central base with injected aluminum base plate. Offered in extruded aluminum and rounded or squared shape. Available in earth brown, white or matte black. It can combine with any model from the Outdoor Top Collection. Available in 2 different diameters and 2 heights.

Base central de mesa con pie de inyección de aluminio combinable con columnas redondas o cuadradas de aluminio extruido. Disponible en acabados marrón tierra, blanco o negro mate. Combinable con cualquier modelo de la colección Top Outdoor. Disponible en 2 diámetros y 2 alturas diferentes.

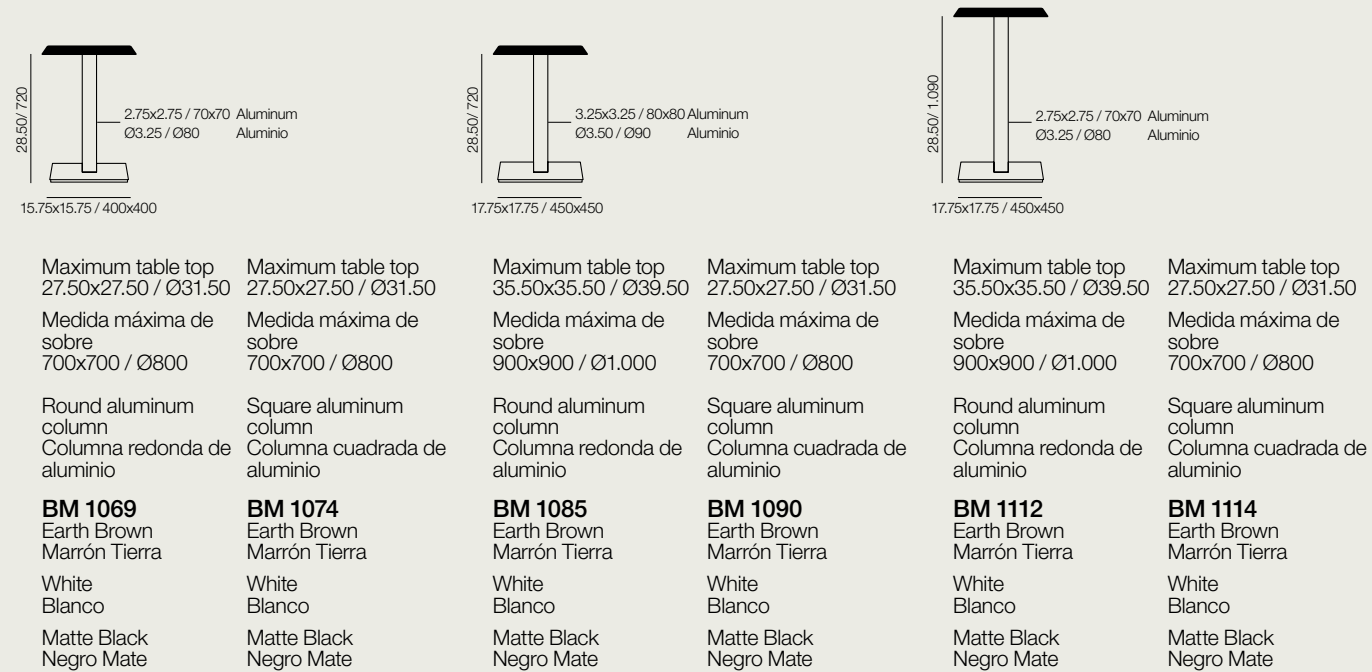

Measurements in./mm.
Medidas in./mm.

Aluminum finish / Acabado de aluminio

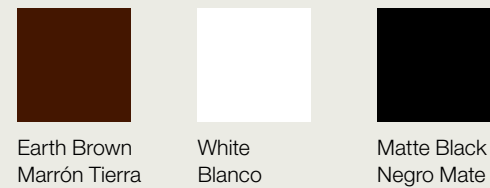

Certificates / Certificados

Aluminum UNE CEN/TR 581-4 Durability of exterior-grade furniture
Aluminio Durabilidad de mobiliario de exterior

BM 1085 + SB 4572



BM 1074 + SB 4572



Injected aluminum four-star base. Available in 2 sizes and 4 heights and offered in Earth Brown, White or Matte Black. Combinable with any model from our outdoor Top Collections.

Base de 4 aspas de inyección de aluminio. Disponible en 2 tamaños y 4 alturas diferentes. Se ofrece en acabados Marrón Tierra, Blanco o Negro Mate. Combinable con cualquier modelo de las colecciones Top de Andreu World outdoor.



Aluminum finish
Acabado aluminio
Aluminum finish
Acabado aluminio
Aluminum finish
Acabado aluminio

Maximum table top
31.50x31.50 / Ø35.50

Medida máxima de sobre
800x800 / Ø900

BM 4704
Earth Brown
Marrón Tierra

White
Blanco

Matte Black
Negro Mate

Maximum table top
31.50x31.50 / Ø35.50

Medida máxima de sobre
800x800 / Ø900

BM 4707
Earth Brown
Marrón Tierra

White
Blanco

Matte Black
Negro Mate

Maximum table top
31.50x31.50 / Ø35.50

Medida máxima de sobre
800x800 / Ø900

BM 4709
Earth Brown
Marrón Tierra

White
Blanco

Matte Black
Negro Mate

Maximum table top
27.50x27.50 / Ø31.50

Medida máxima de sobre
700x700 / Ø800

BM 4711
Earth Brown
Marrón Tierra

White
Blanco

Matte Black
Negro Mate



Aluminum finish
Acabado aluminio
Aluminum finish
Acabado aluminio
Aluminum finish
Acabado aluminio

Maximum table top
43.25 x43.25 / Ø47.25

Medida máxima de sobre
1.100x1.100 / Ø1.200

BM 4713
Earth Brown
Marrón Tierra

White
Blanco

Matte Black
Negro Mate

Maximum table top
43.25 x43.25 / Ø47.25

Medida máxima de sobre
1.100x1.100 / Ø1.200

BM 4715
Earth Brown
Marrón Tierra

White
Blanco

Matte Black
Negro Mate

Maximum table top
43.25 x43.25 / Ø47.25

Medida máxima de sobre
1.100x1.100 / Ø1.200

BM 4717
Earth Brown
Marrón Tierra

White
Blanco

Matte Black
Negro Mate

Maximum table top
31.50x31.50 / Ø35.50

Medida máxima de sobre
800x800 / Ø900

BM 4719
Earth Brown
Marrón Tierra

White
Blanco

Matte Black
Negro Mate

Measurements in./mm.
Medidas in./mm.

Injected aluminum four-star base. Available in 2 heights and offered in Earth Brown, White or Matte Black and with Technical stone or solid core high pressure laminate top (HPL)

Base de 4 aspas de inyección de aluminio. Disponible en 2 alturas. Se ofrece en acabados Marrón Tierra, Blanco o Negro Mate y sobres Cerámicos o Compacto laminado de alta presión HPL.

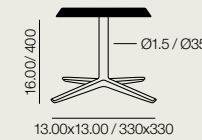

Aluminum finish
Acabado aluminio
Aluminum finish
Acabado aluminio
Aluminum finish
Acabado aluminio

Top measures
17.75x17.75

Medida sobre
450x450

Table top
Sobre
Compacto HPL

ME 6775
Earth Brown
Marrón Tierra

White
Blanco

Matte Black
Negro Mate

Top measures ellipse
17.75x17.75

Medida sobre elipse
450x450

Table top
Sobre
Compacto HPL

ME 6780
Earth Brown
Marrón Tierra

White
Blanco

Matte Black
Negro Mate

Top measures
Ø19.75

Medida sobre
Ø500

Table top
Sobre
Compacto HPL

ME 6785
Earth Brown
Marrón Tierra

White
Blanco

Matte Black
Negro Mate

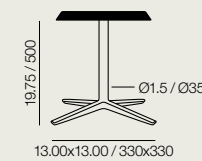

Aluminum finish
Acabado aluminio
Aluminum finish
Acabado aluminio
Aluminum finish
Acabado aluminio

Top measures
17.75x17.75

Medida sobre
450x450

Table top
Sobre
Compacto HPL

ME 6790
Earth Brown
Marrón Tierra

White
Blanco

Matte Black
Negro Mate

Top measures ellipse
17.75x17.75

Medida sobre elipse
450x450

Table top
Sobre
Compacto HPL

ME 6795
Earth Brown
Marrón Tierra

White
Blanco

Matte Black
Negro Mate

Top measures
Ø19.75

Medida sobre
Ø500

Table top
Sobre
Compacto HPL

ME 6800
Earth Brown
Marrón Tierra

White
Blanco

Matte Black
Negro Mate

Aluminum finish / Acabado de aluminio



Earth Brown
Marrón Tierra

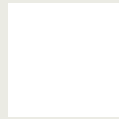

White
Blanco



Matte Black
Negro Mate

Certificates / Certificados

Aluminum	UNE CEN/TR 581-4	Durability of exterior-grade furniture
Aluminio		Durabilidad de mobiliario de exterior

Quattro Occasional

Aluminum finish / Acabado de aluminio



Earth Brown
Marrón Tierra

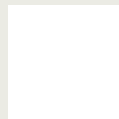

White
Blanco



Matte Black
Negro Mate

Compact HPL finish / Acabado Compact HPL

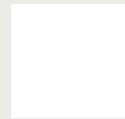

White
Blanco



Matte Black
Negro Mate

Technical stone decorative finish / Acabado cerámica decorativa

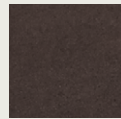

Earth Brown
Marrón Tierra



Sand Grey
Gris Arena



Stone Grey
Gris Piedra

Certificates / Certificados

Aluminum	UNE CEN/TR 581-4	Durability of exterior-grade furniture
Aluminio		Durabilidad de mobiliario de exterior
Compacto	EN 438-6, EN 4382-2-10, EN 4382-2-12, EN 4382-2-14, EN 4382-2-16, EN 4382-2-17, EN 4382-2-21, EN 4382-2-24, EN 4382-2-25, EN 4382-2-26, EN 4382-2-27, EN 4382-2-30, EN 12721	European Standard UNE EN 13501

BM 4713 + SB 4792
BM 4715 + SB 4594
BM 4709 + SB 4792



Quattro Occasional
ME 6790



Quattro Occasional
ME 6785



Table collection with four injected aluminum legs with EPL-5 outdoor treatment, available in Earth Brown, White or Matte Black finish with Technical stone and solid core high pressure laminate top (HPL).

Colección de mesas con base de 4 patas de inyección de aluminio con tratamiento EPL-5 en acabado Marrón Tierra, Blanco o Negro Mate y sobres Cerámicos o sobres de Compacto laminado de alta presión (HPL).



Table top 29.50x29.50	Table top 47.25x47.25	Table top 29.50x19.75	Table top 47.25x23.75	Table top 23.75x23.75	Table top 47.25x47.25	Table top 47.25x23.75	Table top 55.25x27.50
Sobre 750x750	Sobre 1.200x1.200	Sobre 750x500	Sobre 1.200x600	Sobre 600x600	Sobre 1.200x1.200	Sobre 1.200x600	Sobre 1.400x700
ME 8667 Earth Brown Marrón Tierra	ME 8672 Earth Brown Marrón Tierra	ME 8677 Earth Brown Marrón Tierra	ME 8682 Earth Brown Marrón Tierra	ME 8687 Earth Brown Marrón Tierra	ME 8692 Earth Brown Marrón Tierra	ME 8697 Earth Brown Marrón Tierra	ME 8702 Earth Brown Marrón Tierra
White Blanco	White Blanco	White Blanco	White Blanco	White Blanco	White Blanco	White Blanco	White Blanco
Matte Black Negro Mate	Matte Black Negro Mate	Matte Black Negro Mate	Matte Black Negro Mate	Matte Black Negro Mate	Matte Black Negro Mate	Matte Black Negro Mate	Matte Black Negro Mate

Measurements in./mm.
Medidas in./mm.

Aluminum finish / Acabado de aluminio



Earth Brown
Marrón Tierra

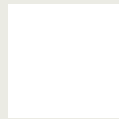

White
Blanco



Matte Black
Negro Mate

Compact HPL finish / Acabado Compact HPL

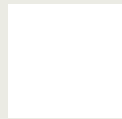

White
Blanco



Matte Black
Negro Mate

Technical stone decorative finish / Acabado cerámica decorativa

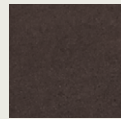

Earth Brown
Marrón Tierra



Sand Grey
Gris Arena



Stone Grey
Gris Piedra

Certificates / Certificados

Aluminum
Aluminio

Durability of exterior-grade furniture
Durabilidad de mobiliario de exterior

Compacto
EN 438-6, EN 4382-2-10, EN 4382-2-12, EN 4382-2-14,
EN 4382-2-16, EN 4382-2-17, EN 4382-2-21,
EN 4382-2-24, EN 4382-2-25, EN 4382-2-26,
EN 4382-2-27, EN 4382-2-30, EN 12721

European Standard
UNE EN 13501

ME 8692



ME 8697



100% recyclable polyethylene table base offered in four diameters and six colors.

Base de mesa de polietileno 100% reciclable. Se ofrece en cuatro diámetros de base y seis colores diferentes.

Reverse 38



Maximum table top
35.50x35.50 / Ø39.50

Medida máxima de sobre
900x900 / Ø1.000

BM 4520

Matte
Mate

BM 4522

Bright laquer
Laca brillo

Reverse 50

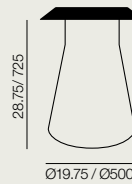

Maximum table top
51.25x51.25 / Ø59.25

Medida máxima de sobre
1.300x1.300 / Ø1.500

BM 4521

Matte
Mate

BM 4523

Bright laquer
Laca brillo

Reverse 42



Maximum table top
35.50x35.50 / Ø39.50

Medida máxima de sobre
900x900 / Ø1.000

BM 4562

Matte
Mate

BM 4563

Bright laquer
Laca brillo

Measurements in./mm.
Medidas in./mm.

Polyethylene finish / Acabado de polietileno

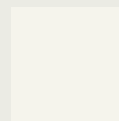

6000
RAL 9003
White
Blanco

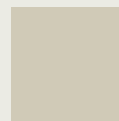

6002
NCS2005-Y20R
Sand
Arena



6012
NCS S 4005-Y20R
Basalt Grey
Gris Basalto



6003
RAL 3013
Cayenne Red
Rojo Cayena

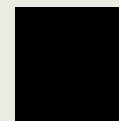

6006
RAL 9005
Black
Negro



6013
NCS S 6502-B
Dark Grey
Gris Oscuro

Certificates / Certificados

Quality-Resistance UNE EN 15372:2008
Calidad-Resistencia

BM 4562



BM 4523



Occasional table with polyethylene central base, available in 6 different colors. Available in two heights. Top of Compact high pressure HPL and Technical stone, in three shapes: square, elliptical and round and a dimension for every top shape.

Mesa auxiliar con base central de polietileno disponible en 6 colores diferentes. Disponible en 2 alturas. Sobre Compacto de alta presión HPL y cerámico, en 3 formas diferentes, cuadrado, elíptico y redondo, con una medida para cada forma de sobre.

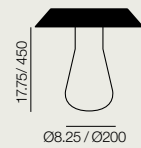

Column height
17.75
Altura columna
450

Table top
Sobre
Compacto HPL

ME 5104
Top measures 15.75x15.75
Medidas sobre 400x400

ME 5109
Top measures 15.75x15.75 ellipse
Medidas sobre 400x400 elipse

ME 5114
Top measures Ø21.75
Medidas sobre Ø450

Measurements in./mm.
Medidas in./mm.

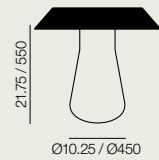

Column height
17.75
Altura columna
450

Table top
Sobre
Compacto HPL

ME 5119
Top measures 19.75x19.75
Medidas sobre 500x500

ME 5124
Top measures 19.75x19.75 ellipse
Medidas sobre 500x500 elipse

ME 5129
Top measures Ø21.75
Medidas sobre Ø450

Polyethylene finish / Acabado de polietileno



6000
RAL 9003
White
Blanco

6002
NCS2005-Y20R
Sand
Arena

6012
NCS S 4005-Y20R
Basalt Grey
Gris Basalto

6003
RAL 3013
Cayenne Red
Rojo Cayena

6006
RAL 9005
Black
Negro

6013
NCS S 6502-B
Dark Grey
Gris Oscuro

Compact HPL finish / Acabado Compact HPL



White
Blanco

Matte Black
Negro Mate

Technical stone decorative finish / Acabado cerámica decorativa



Earth Brown
Marrón Tierra

Sand Grey
Gris Arena

Stone Grey
Gris Piedra

Certificates / Certificados

Quality-Resistance UNE EN 15372:2008
Calidad-Resistencia

ME 5129



ME 5129 ME 5114



Coffee table with EPL-5 outdoor treated steel frame in White or Earth Brown. Decorative technical stone tops in Earth Brown, Sand Grey and Stone Grey.

Mesa de centro con estructura de acero con tratamiento EPL-5 disponible en color Blanco o Marrón Tierra. Sobre de cerámica decorativa en Marrón Tierra, Gris Arena y Gris Piedra.

ME 4315

ME 4313

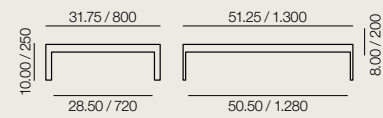
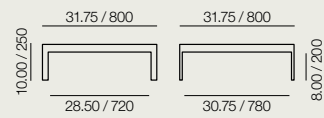

Measurements in./mm.
Medidas in./mm.

ME 4315

Coffee table.
Decorative technical stone table top.

Mesa de centro. Sobre de cerámica decorativa.

ME 4313

Coffee table.
Decorative technical stone table top.

Mesa de centro. Sobre de cerámica decorativa.

Steel finish / Acabado de acero



Earth Brown
Marrón Tierra

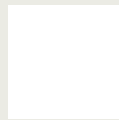

White
Blanco

Technical stone decorative finish / Acabado cerámica decorativa

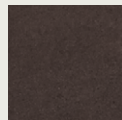

Earth Brown
Marrón Tierra



Sand Grey
Gris Arena

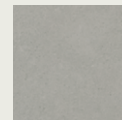

Stone Grey
Gris Piedra

Certificates / Certificados

EPL-5 Steel / Acero EPL-5 UNE CEN/TR 581-4 Durability of exterior-grade furniture / Durabilidad de mobiliario de exterior

Technical stone table top / Top cerámico decorativo European Standard: UNE EN 13501-1:2 UNE EN ISO 10545-3, UNE EN ISO 10545-4, UNE EN ISO 10545-6, UNE EN 12633, UNE EN ISO 10545-12, UNE EN ISO 10545-9

ME 4315+ME 4313

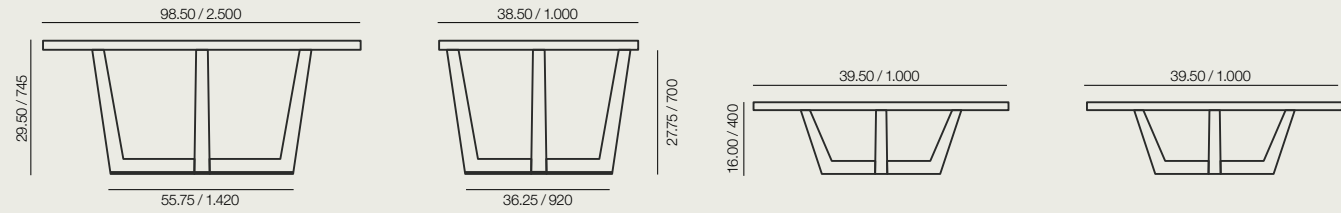

Table with an EPL-5 treated steel base in White or Earth Brown finish and technical stone top available in Earth Brown, Sand Grey or Stone Grey. Available in occasional table version.

Mesa con base de acero con tratamiento EPL-5 en acabado Blanco o Marrón Tierra y sobre de cerámica decorativa disponible en color Marrón Tierra, Gris Arena y Gris Piedra. Disponible versión mesa auxiliar.

ME 4692 Terra

ME 4693 Terra Occasional



Measurements in./mm.
Medidas in./mm.

ME 4692

Table.
Technical stone
table top.

Mesa. Sobre
de cerámica
decorativa.

ME 4693

Occasional table.
Technical stone
table top.

Mesa auxiliar.
Sobre de cerámica
decorativa.

Steel finish / Acabado de acero



Earth Brown
Marrón Tierra

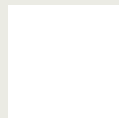

White
Blanco

Technical stone decorative finish / Acabado cerámica decorativa

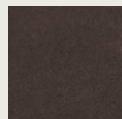

Earth Brown
Marrón Tierra



Sand Grey
Gris Arena

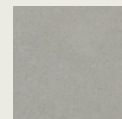

Stone Grey
Gris Piedra

Certificates / Certificados

EPL-5 Steel
Acero EPL-5

UNE CEN/TR 581-4

Durability of exterior-grade furniture
Durabilidad de mobiliario de exterior

Technical stone table top
Top cerámico decorativo

European Standard:
UNE EN 13501-1:2

UNE EN ISO 10545-3, UNE EN ISO 10545-4, UNE EN ISO 10545-6, UNE EN 12633, UNE EN ISO 10545-12, UNE EN ISO 10545-9

ME 4692



ME 4692



ME 4693



Collection of fixed aluminum frame tables paired with technical stone table tops in Earth Brown, Sand Grey and Stone Grey and Compacto high pressure top HPL. Legs are aluminum.

Colección de mesas fijas con marco de perfil de aluminio, que combina sobres de cerámica en Marrón Tierra, Gris Arena y Gris Piedra y sobres Compactos de alta presión HPL. Patas de aluminio.

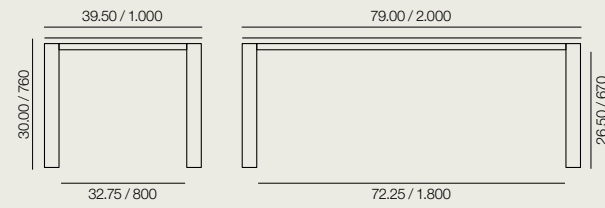
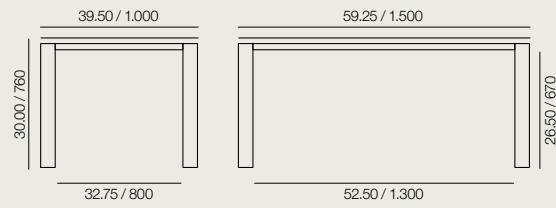

Technical stone Table top / Sobre Cerámica
Table top Compacto HPL / Sobre Compacto HPL

- ME 5894**
Aluminum 4.00x4.00 legs
Patas aluminio 100x100
- ME 5885**
Delta
- FU 4815**
- ME 5451**
Aluminum 4.00x4.00 legs
Patas aluminio 100x100
- ME 5452**
Delta
- FU 4815**

Technical stone Table top / Sobre Cerámica
Table top Compacto HPL / Sobre Compacto HPL

- ME 5895**
Aluminum 4.00x4.00 legs
Patas aluminio 100x100
- ME 5887**
Delta
- FU 4816**
- ME 5454**
Aluminum 4.00x4.00 legs
Patas aluminio 100x100
- ME 5455**
Delta
- FU 4816**

Measurements in./mm.
Medidas in./mm.

Compact HPL Tops / Sobres Compacto HPL



White / Blanco
Matte Black / Negro Mate

Aluminum finish / Acabado de aluminio



Earth Brown / Marrón Tierra

Technical stone decorative finish / Acabado cerámica decorativa



Earth Brown / Marrón Tierra
Sand Grey / Gris Arena
Stone Grey / Gris Piedra

Certificates / Certificados

Aluminum / Aluminio	UNE CEN/TR 581-4	Durability of exterior-grade furniture / Durabilidad de mobiliario de exterior
Technical stone table top / Top cerámico decorativo	European Standard: UNE EN 13501-1:	UNE EN ISO 10545-3, UNE EN ISO 10545-4, UNE EN ISO 10545-6, UNE EN 12633, UNE EN ISO 10545-12, UNE EN ISO 10545-9

ME 5895



ME 5457

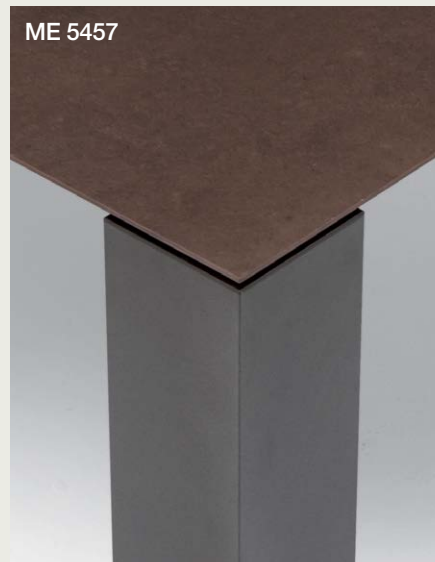

ME 5896



Our table top catalog provides extraordinary possibilities for outdoor environments, both in materials finishes and colors. In combination with Plaza, Dual, Reverse, and Quattro bases, they create an offering capable of adapting to any project. Materials such as technical stone or solid surface, glass and high pressure laminate, guarantee durability, beauty, and easy maintenance.



Technical stone Decorative Top

Square and round tables tops with 0.23 inch (6mm) technical stone layer. Square top has protective back edge cover. Also available for outdoor use. The total thickness of table top is 0.70 inch (18mm) and includes 0.47 inch (12mm) Compacto HPL layer.

Top Cerámico Decorativo

Tablero de mesa cerámico de 6mm. en sobres redondos y de 6mm. con canto protector de color negro en sobres cuadrados. válido para su uso en exterior. El espesor total del sobre es de 18mm. (6mm. de tablero cerámico + 12mm. de soporte de tablero Compacto HPL).



23.75 x 23.75	600 x 600	SB 4535	Ø23.75	Ø600	SB 4540
27.50 x 27.50	700 x 700	SB 4536	Ø27.50	Ø700	SB 4541
31.50 x 31.50	800 x 800	SB 4537	Ø31.50	Ø800	SB 4542
35.50 x 35.50	900 x 900	SB 4538	Ø35.50	Ø900	SB 4543
39.50 x 39.50	1.000 x 1.000	SB 4539	Ø39.50	Ø1.000	SB 4544

Measurements in./mm.
Medidas in./mm.

Technical stone decorative finish / Acabado cerámica decorativa

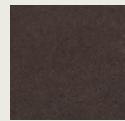

Earth Brown
Marrón Tierra



Sand Grey
Gris Arena



Stone Grey
Gris Piedra

Certificates / Certificados

Technical stone decorative table top Top cerámico decorativo	European Standard: UNE EN 13501-1:2	International Standards UNE EN ISO 10545-3, UNE EN ISO 10545-4, UNE EN ISO 10545-6, ENV 12633, UNE EN ISO 10545-12, UNE EN ISO 10545-9.
---	--	--

Las posibilidades que ofrece nuestro catálogo de sobres de mesa para ambientes outdoor son extraordinarias, tanto en materiales como en acabados y colores. En combinación con las bases Plaza, Dual, Reverse y Quattro configuran una oferta capaz de adaptarse a cualquier proyecto. Materiales como la cerámica, o las superficies sintéticas (Solid Surfaces), el cristal o los tableros compactos HPL garantizan su resistencia, belleza y facilidad de mantenimiento.



Top Compacto HPL

High pressure laminate table top of 0.47 inch (12mm) thickness. Suitable for outdoor and high traffic areas. Able to be combined with all central column base collections.

Top Compacto HPL

Tablero Compacto laminado de alta presión (HPL) de 12mm. Válido para exterior y áreas de uso intenso. Válido para cualquier base de columna central.



23.75 x 23.75	600 x 600	SB 4570	Ø23.75	Ø600	SB 4580	23.75 x 23.75	600 x 600	SB 4591
27.50 x 27.50	700 x 700	SB 4571	Ø27.50	Ø700	SB 4581	27.50 x 27.50	700 x 700	SB 4592
31.50 x 31.50	800 x 800	SB 4572	Ø31.50	Ø800	SB 4582	31.50 x 31.50	800 x 800	SB 4593
35.50 x 35.50	900 x 900	SB 4573	Ø35.50	Ø900	SB 4583	35.50 x 35.50	900 x 900	SB 4594
39.50 x 39.50	1.000 x 1.000	SB 4574	Ø39.50	Ø1.000	SB 4584	39.50 x 39.50	1.000 x 1.000	SB 4595
43.25 x 43.25	1.100 x 1.100	SB 4575	Ø43.25	Ø1.100	SB 4585	43.25 x 43.25	1.100 x 1.100	SB 4596
47.25 x 47.25	1.200 x 1.200	SB 4576	Ø47.25	Ø1.200	SB 4586	47.25 x 47.25	1.200 x 1.200	SB 4597
51.25 x 51.25	1.300 x 1.300	SB 4577	Ø51.25	Ø1.300	SB 4587	51.25 x 51.25	1.300 x 1.300	SB 4598
55.25 x 55.25	1.400 x 1.400	SB 4578	Ø55.25	Ø1.400	SB 4588	55.25 x 55.25	1.400 x 1.400	SB 4599

Measurements in./mm.
Medidas in./mm.

Compacto HPL finish / Acabado Compacto HPL



White
Blanco

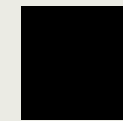

Matte Black
Negro Mate

Certificates / Certificados

EN 438-2-4, EN 438-2-5, EN 438-2-6, EN 438-2-7, EN 438-2-8, EN 438-2-9, EN 438-2-10, EN 438-2-12, EN 438-2-14, EN 438-2-16, EN 12721, EN 438-2-17, EN 438-2-21, EN 438-2-24, EN 438-2-25, EN 438-2-26, EN 438-2-27, EN 438-2-30, EN ISO 1183-1, ISO 178:2003, ISO R527:1996	European Standard: UNE EN 13501
---	------------------------------------



Solid Surface Top

Solid surface table top of 0.47 inch (12mm) thickness. Available in Glacier White color. Able to be combined with all column base collections. Suitable for outdoor use.

Top Solid Surface

Sobre de Solid Surface de 12mm. de espesor. Disponible en color Glacier White. Válido para cualquier colección de columnas. Válido para uso en exterior.



23.75 x 23.75	600 x 600	SB 3592
27.50 x 27.50	700 x 700	SB 3593
31.50 x 31.50	800 x 800	SB 3594
35.50 x 35.50	900 x 900	SB 3595



Ø23.75	Ø600	SB 3596
Ø27.50	Ø700	SB 3597
Ø31.50	Ø800	SB 3598
Ø35.50	Ø900	SB 3599



23.75 x 23.75	600 x 600	SB 3614
27.50 x 27.50	700 x 700	SB 3615
31.50 x 31.50	800 x 800	SB 3616
35.50 x 35.50	900 x 900	SB 3617

Measurements in./mm.
Medidas in./mm.

Solid Surface finish / Acabado Solid Surface

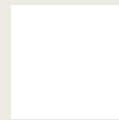

Glacier White

Certificates / Certificados

DIN ISO 1183, DIN EN ISO 178, EN ISO 604, European Standard: UNE EN 13501
DIN ISO 4586 T11, DIN ISO 4586 T12, DIN EN 101, DIN ISO 4586 T6, DIN ISO 4586 T7, DIN EN ISO 846, DIN 51130:1992-11, DIN ISO 4586 T10, DIN ISO 4586 T8, DIN ISO 4586 T16, DIN IEC 61 340-4-1.



Glass Top

Tempered glass top of 0.39 inch (10mm) thickness, available in various colors and gloss finish. Low-iron glass version available. Able to be combined with all the central column table base collections. Suitable for outdoor use. The total thickness of table top is 0.86 inches and includes 0.47 (12 mm) Compacto HPL layer.

Top Glass

Cristal templado de 10mm. de espesor, disponible en varios colores y acabado brillo. Versión de cristal óptico. Válido para cualquier colección de columna central y su uso en exterior. El espesor total del sobre es 22mm. (10mm. de cristal + 12mm. de Compacto).



		Glass Cristal	Optical Glass Cristal Óptico
23.75 x 23.75	600 x 600	SB 4530	SB 4766
27.50 x 27.50	700 x 700	SB 4555	SB 4767
31.50 x 31.50	800 x 800	SB 4556	SB 4768
35.50 x 35.50	900 x 900	SB 4557	SB 4769
39.50 x 39.50	1.000 x 1.000	SB 4558	SB 4770
43.25 x 43.25	1.100 x 1.100	SB 4531	SB 4771
47.25 x 47.25	1.200 x 1.200	SB 4559	SB 4772
51.25 x 51.25	1.300 x 1.300	SB 4532	SB 4773
55.25 x 55.25	1.400 x 1.400	SB 4560	SB 4774
59.00 x 59.00	1.500 x 1.500	SB 4533	SB 4775



		Glass Cristal	Optical Glass Cristal Óptico
Ø23.75	Ø600	SB 4515	SB 4776
Ø27.50	Ø700	SB 4507	SB 4777
Ø31.50	Ø800	SB 4508	SB 4778
Ø35.50	Ø900	SB 4509	SB 4779
Ø39.50	Ø1.000	SB 4510	SB 4780
Ø43.25	Ø1.100	SB 4516	SB 4781
Ø47.25	Ø1.200	SB 4511	SB 4782
Ø51.25	Ø1.300	SB 4517	SB 4783
Ø55.25	Ø1.400	SB 4512	SB 4784
Ø59.00	Ø1.500	SB 4518	SB 4785



		Glass Cristal	Optical Glass Cristal Óptico
23.75 x 23.75	600 x 600	SB 4639	SB 4786
27.50 x 27.50	700 x 700	SB 4640	SB 4787
31.50 x 31.50	800 x 800	SB 4641	SB 4788
35.50 x 35.50	900 x 900	SB 4642	SB 4789
39.50 x 39.50	1.000 x 1.000	SB 4643	SB 4790
43.25 x 43.25	1.100 x 1.100	SB 4644	SB 4791
47.25 x 47.25	1.200 x 1.200	SB 4645	SB 4792
51.25 x 51.25	1.300 x 1.300	SB 4646	SB 4793
55.25 x 55.25	1.400 x 1.400	SB 4647	SB 4794
59.00 x 59.00	1.500 x 1.500	SB 4648	SB 4795

Measurements in./mm.
Medidas in./mm.

Glass finish / Acabado de cristal

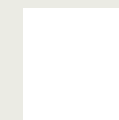

White
Blanco



Sand
Arena



Basalt Grey
Gris Basalto



Cayenne Red
Rojo Cayena



Matte Black
Negro Mate



Dark Grey
Gris Oscuro

Certificates / Certificados

EN 438-2-4, EN 438-2-5, EN 438-2-6, EN 438-2-7, EN 438-2-8, EN 438-2-9, EN 438-2-10, EN 438-2-12, EN 438-2-14, EN 438-2-16, EN 12721, EN 438-2-17, EN 438-2-21, EN 438-2-24, EN 438-2-25, EN 438-2-26, EN 438-2-27, EN 438-2-30, EN ISO 1183-1, ISO 178:2003, ISO R527:1996
European Standard: UNE EN 13501



Top 18 laminate

18mm laminate top that is suitable for high traffic areas. Suitable to be combined with all central column base collections.

Top 18 laminado

Tablero de 18 mm laminado preparado para áreas de uso intenso. Válido para cualquier base de columna central.



23.75 x 23.75	600 x 600	SB 3471	Ø23.75	Ø600	SB 3477	23.75 x 23.75	600 x 600	SB 3940
27.50 x 27.50	700 x 700	SB 3472	Ø27.50	Ø700	SB 3478	27.50 x 27.50	700 x 700	SB 3941
31.50 x 31.50	800 x 800	SB 3473	Ø31.50	Ø800	SB 3479	31.50 x 31.50	800 x 800	SB 3942
35.50 x 35.50	900 x 900	SB 3474	Ø35.50	Ø900	SB 3480	35.50 x 35.50	900 x 900	SB 3943
39.50 x 39.50	1.000 x 1.000	SB 3486	Ø39.50	Ø1.000	SB 3481	39.50 x 39.50	1.000 x 1.000	SB 3944
43.25 x 43.25	1.100 x 1.100	SB 3487	Ø43.25	Ø1.100	SB 3482	43.25 x 43.25	1.100 x 1.100	SB 3945
47.25 x 47.25	1.200 x 1.200	SB 3488	Ø47.25	Ø1.200	SB 3483	47.25 x 47.25	1.200 x 1.200	SB 3946
51.25 x 51.25	1.300 x 1.300	SB 3456	Ø51.25	Ø1.300	SB 3484	51.25 x 51.25	1.300 x 1.300	SB 3947
55.25 x 55.25	1.400 x 1.400	SB 3540	Ø55.25	Ø1.400	SB 3542	55.25 x 55.25	1.400 x 1.400	SB 3948

Measurements in./mm.
Medidas in./mm.

Laminate finish / Acabado de laminado

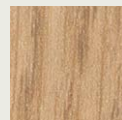

L205
Oak
Roble

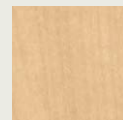

L204
Maple
Arce

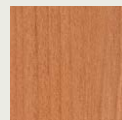

L203
Cherry
Cerezo

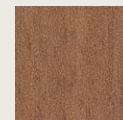

L202
Light Walnut
Nogal claro

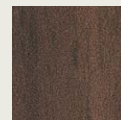

L206
Dark Walnut
Nogal oscuro

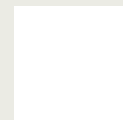

L200
White
Blanco

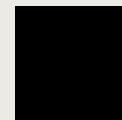

L201
Black
Negro



645L
NCS 2005-Y20R
Sand
Arena



646L
NCS S 4005-Y20R
Basalt grey
Gris basalto



605L
NCS S 6502-B
Dark grey
Gris oscuro

Materials

Materiales

All of the Andreu World Outdoor collections are fabricated with materials of the highest quality, ideal for exterior use, on a patio or interior, durable and reliable, elegant and always comfortable. These materials are sustainability manufactured with the utmost respect to the environment.

Todas las colecciones de Andreu World Outdoor están fabricadas con materiales de la máxima calidad, idóneos para sus usos en exterior, bajo porche o interior, resistentes y fiables, elegantes y siempre confortables. Estos materiales –a su vez– se obtienen de procesos de fabricación sostenibles y respetuosos con el medio ambiente.

Teak / Teka

It combines all the values of a natural material intended for exterior applications. From the beginning, Andreu World has utilized high quality teak wood from controlled sources. This material provides great structural strength as well as climate agents and is extremely durable, offering a long life-cycle and a warm design for our Outdoor collections made in teak.

Reúne todos los valores de un material natural pensado para el exterior. Desde el origen, Andreu World utiliza madera de teca de alta calidad procedente de fuentes controladas. Este material ofrece una gran resistencia estructural así como a los agentes climáticos y es extremadamente duradera, ofreciendo un ciclo de vida prolongado y un diseño cálido para nuestras colecciones Outdoor realizadas en teca.

For / Para:
Serena Teak

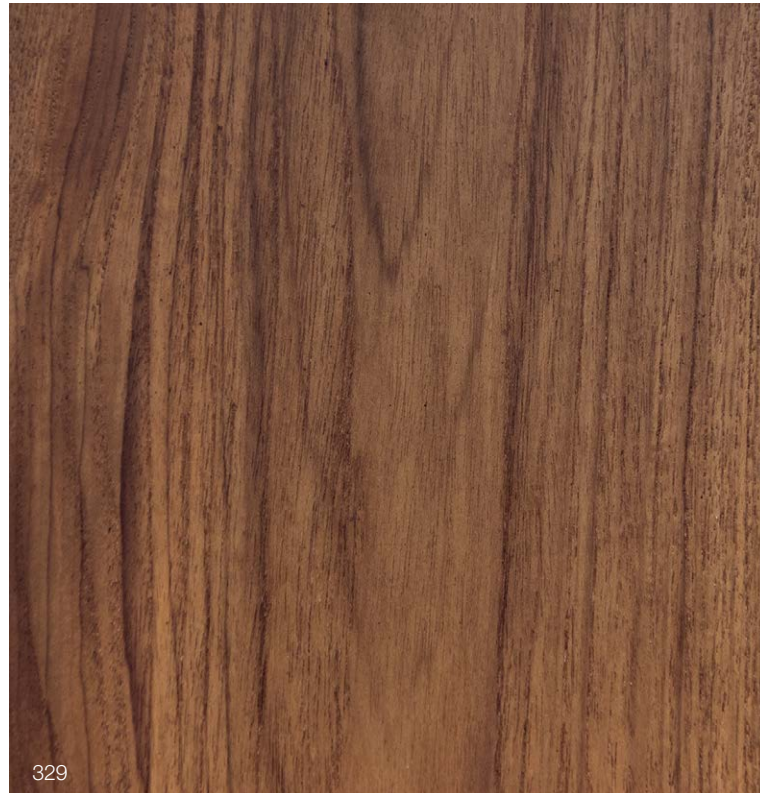

329

Maintenance and cleaning

Our teak furniture has a protective treatment that protects them from moisture but, with time and exposure to the elements, this treatment naturally disappears. For its maintenance, we recommend periodically treating the wood with protective treatment.

Mantenimiento y limpieza

Nuestros muebles de teca llevan un tratamiento protector que los protege de la humedad pero, con el tiempo y la exposición a la intemperie, este tratamiento va desapareciendo de forma natural. Para su mantenimiento, recomendamos tratar la madera con tratamiento protector de forma periódica.

Technical stone / Cerámica

Technical stone table tops are impermeable, hygienic and colorfast. All of these characteristics make it the ideal material for outdoor table tops in addition to being fireproof and resistant to abrasion. Technical stone is 100% recyclable.

Los tableros cerámicos son impermeables, higiénicos y presentan colores inalterables lo que le convierte en un material ideal para los sobres de mesas outdoor. Son ignífugos y resistentes a la abrasión. La cerámica es 100% reciclable.

For / Para:
Dual Occasional
Quattro Occasional
Raglan Table
Reverse Occasional
Sand Table
Terra
Terra Occasional
Wind
Technical stone

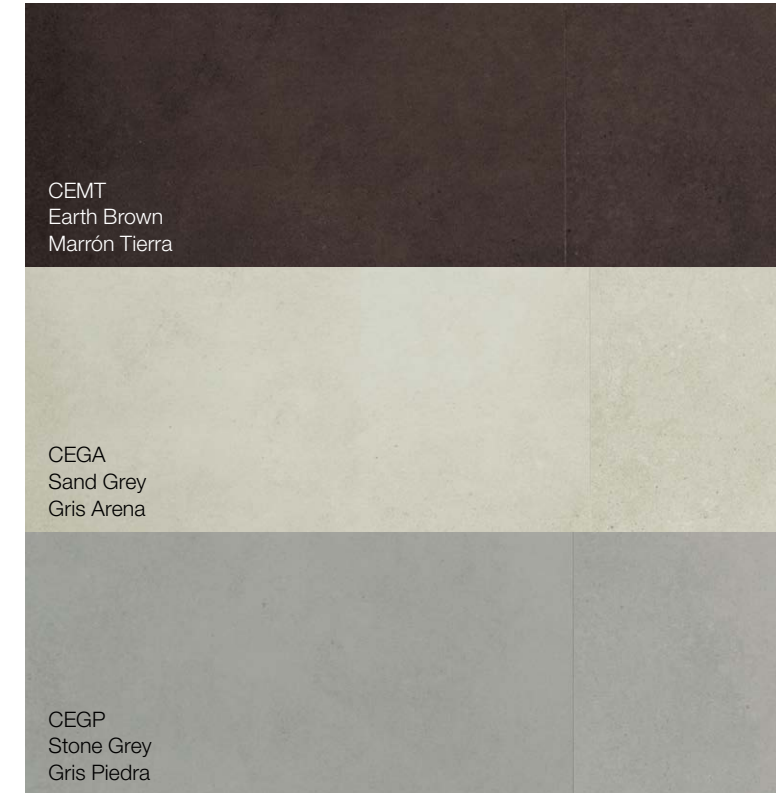

Certifications / Certificaciones

Absorption of water / Absorción del agua	UNE EN ISO 10545-3
Bending resistance / Resistencia a la flexión	UNE EN ISO 10545-4
Surface hardness / Dureza superficial (Escala MOHS)	UNE EN ISO 67-101
Resistance to chemical abrasion / Resistencia al ataque químico	UNE EN ISO 10545-13
Resistance to freezing / Resistencia a las heladas	UNE EN ISO 10545-12
Fire resistance / Resistencia al fuego	Comission Decisión 96/603/EC
Impact (coefficient of restitution) / Impacto (coeficiente de restitución)	UNE EN ISO 10545-5

Resistance to stains / Resistencia a las manchas	UNE EN ISO 10545-14
Slip (coefficient of friction) / Deslizamiento (coef. de fricción)	UNE ENV 12633
Thermal shock resistance / Resistencia al choque térmico	UNE EN ISO 10545-9

Maintenance and cleaning / Mantenimiento y limpieza

For cleaning it is recommended to use a non-abrasive sponge, warm water and a neutral detergent. For stubborn stains, an alkaline or descaling cleaner should be applied. Para su limpieza se recomienda usar una esponja no abrasiva, agua caliente y detergente común. Para las manchas profundas se debe emplear un detergente alcalino o un desincrustante.

Solid Surface

Solid Surface is a non-porous and homogeneous materials comprised of natural minerals and a small percentage of highly durable resins. The Solid Surface Top collection consists of 0.47 inch thick (12mm) table tops. These tops, made of natural minerals, are similar in appearance and feel to natural stone and are available in white. They can be used with any of the column table bases and are suitable for outdoor use.

Solid Surface es un material compacto y homogéneo, compuesto de minerales naturales y un bajo porcentaje de resinas de alta resistencia. La colección Top Solid Surface se compone de sobres de 12mm. de espesor. Estos sobres, compuestos por minerales naturales, son en su apariencia y tacto similares a la piedra natural. Disponible en color blanco y combinable con cualquier base de mesa de columna central. Válido para uso en exterior.

For / Para:

Dual
Plaza
Quattro
Reverse
Top Solid Surface

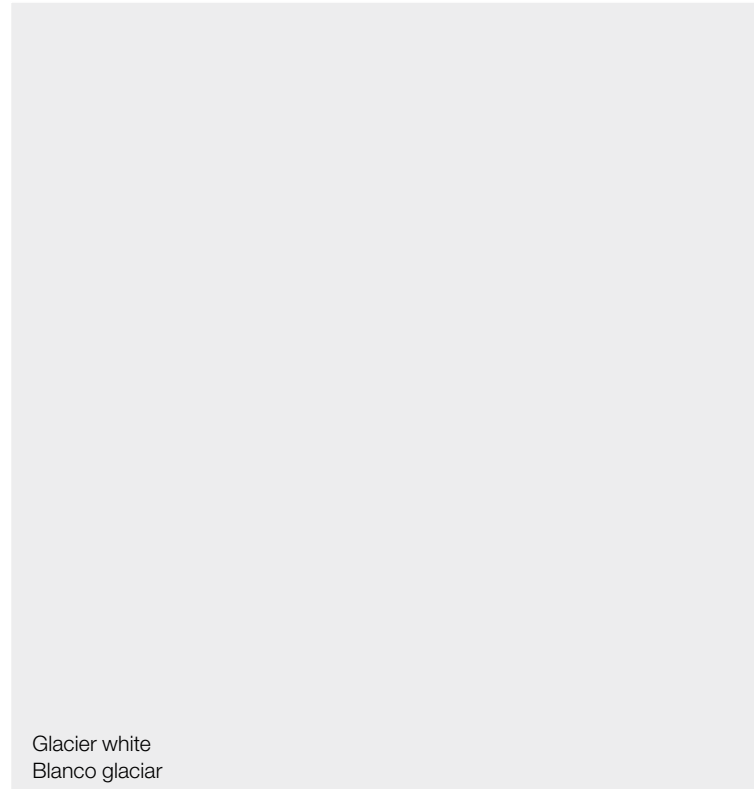

Glacier white
Blanco glaciár

Certifications / Certificaciones

Absorption of water / Absorción del agua	UNE EN ISO 10545-3
Bending resistance / Resistencia a la flexión	UNE EN ISO 10545-4
Surface hardness / Dureza superficial (Escala MOHS)	UNE EN ISO 67-101
Resistance to chemical abrasion / Resistencia al ataque químico	UNE EN ISO 10545-13
Resistance to freezing / Resistencia a las heladas	UNE EN ISO 10545-12
Fire resistance / Resistencia al fuego	Comission Decisión 96/603/EC
Impact (coefficient of restitution) / Impacto (coeficiente de restitución)	UNE EN ISO 10545-5

Resistance to stains / Resistencia a las manchas	UNE EN ISO 10545-14
Slip (coefficient of friction) / Deslizamiento (coef. de fricción)	UNE ENV 12633
Thermal shock resistance / Resistencia al choque térmico	UNE EN ISO 10545-9

Maintenance and cleaning / Mantenimiento y limpieza

The Solid surface tops does not absorb liquids, but is recommended to dry spills or drops immediately. Generally, most stains can be removed using a microfiber cloth dampened with household cleaner spray with circular movements. Los Top Solid Surface no absorben líquidos, pero se recomienda pasar una esponja o bayeta humedecida para secar las salpicaduras. Las manchas en superficie se pueden eliminar utilizando una bayeta de microfibra humedecida con detergente doméstico en spray realizando movimientos circulares.

HPL Top / Tablero Compacto HPL

High pressure table HPL tops are ideal for exterior use. They incorporate a treatment that protects against UV rays, are highly resistant to wear, heat and humidity. They are naturally non-porous which protects from the penetration of dirt.

Los sobres de mesa de tablero compacto HPL son idóneos para su uso en exterior. Incorporan un tratamiento que los protege de la acción UV, unido a la elevada resistencia al desgaste, al calor y a la humedad. La naturaleza no porosa ayuda a que la suciedad no penetre.

For / Para:

Dual
Dual Occasional
Plaza
Quattro
Quattro Occasional
Raglan Table
Reverse Occasional
Wind
Top Compacto HPL

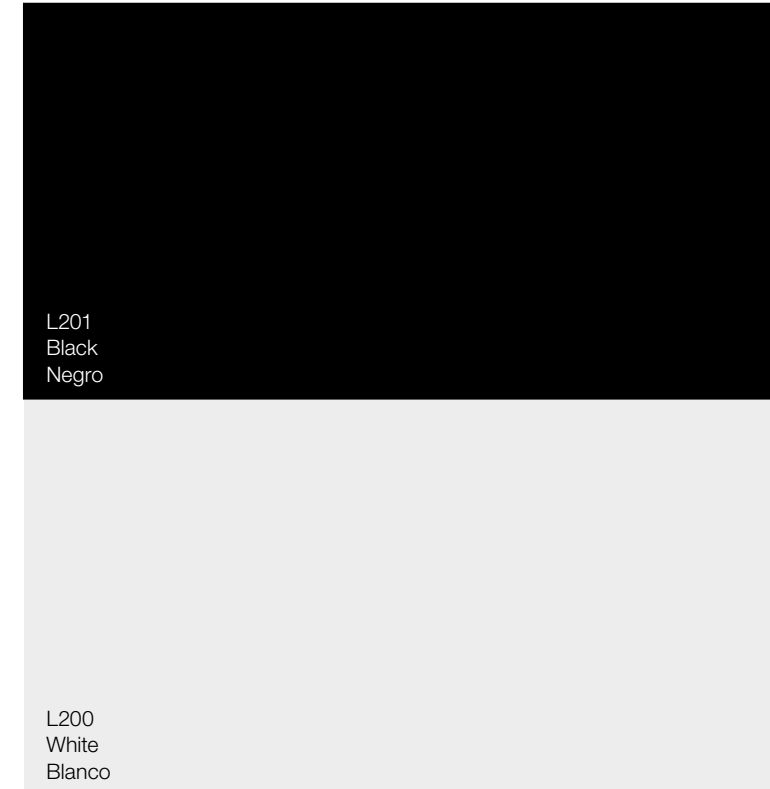

L201
Black
Negro

L200
White
Blanco

Certifications / Certificaciones

Exterior-grade compact laminates (2mm. and thicker) / Compactos para exteriores de 2mm. de espesor y mayores	EN 438-6
Abrasion resistance / Resistencia a la abrasión	EN 438-2-10
Resistance to boiling water / Resistencia al agua hirviendo	EN 438-2-12
Resistance to water vapor / Resistencia al vapor de agua	EN 438-2-12
Resistance to dry heat 180 C / Resistencia al calor seco 180	EN 438-2-16
Resistance to wet heat 180 C / Resistencia al calor húmedo 180	EN 12721
Dimensional stability at high temperature / Estabilidad dimensional a temperatura elevada	EN 438-2-17
Resistance to impact by large-diameter ball / Resistencia al impacto de una bola de gran diámetro	EN 438-2-21
Resistance to crazing / Resistencia al agrietado	EN 438-2-24

Resistance to scratching / Resistencia al rayado	EN 438-2-25
Stain resistance / Resistencia a las manchas	EN 438-2-26
Colorfastness in artificial light / Solidez del color a la luz artificial	EN 438-2-27
Resistance to cigarette burns / Resistencia a las quemaduras de cigarrillo	EN 438-2-30
Fire resistance / Reacción al fuego	C-s1,d0

Maintenance and cleaning / Mantenimiento y limpieza

For maintenance, only cleaning of the surface with a non-abrasive sponge, warm water and soap is required. Para su mantenimiento solo requiere limpiar la superficie con una esponja no abrasiva, agua caliente y jabón.

Glass / Cristal

The Glass Top is made from first class glass fabricated in Europe. All of the glass tops are certified to meet the international quality standards. Its surface has been treated to offer a satin look. Also available is the optical glass option. Additionally, the glass has been manufactured with permanent paint, suitable for outdoor use. The edges are finished with extra care to avoid sharp corners.

Los top Glass se realizan con cristal de primera clase fabricado en Europa. Todos los Top de cristal se certifican con los estándares internacionales de calidad. Su superficie se ha tratado para ofrecer un aspecto satinado y se ofrece también la opción de cristal óptico. Además, el cristal se ha fabricado con pintura permanente, válida para su uso exterior. Los bordes se finalizan con extremo cuidado para evitar las superficies afiladas.

For / Para:
Dual
Plaza
Quattro
Reverse
Top Glass

6000 RAL 9003 White Blanco
6002 NCS 2005-Y20R Sand Arena
6012 NCS S 4005-Y20R Basalt Grey Gris Basalto
6003 RAL 3013 Cayenne Red Rojo Cayena
6006 RAL 9005 Black Negro
6013 NCS S 6502-B Dark Grey Gris Oscuro

Certifications / Certificaciones

Resistance and quality Resistencia y calidad.	ISO 9001
Sustainability. Environmental Management System. Sostenibilidad. Sistema integrado de gestión medioambiental.	ISO 14001

Maintenance and cleaning / Mantenimiento y limpieza

Wet with clean water and neutral detergent. Clean with a microfiber cloth to avoid water stains.
 Humedecer con agua limpia o detergente neutro, y limpiar con una bayeta de microfibra para evitar las manchas de agua.

Steel / Acero

The Andreu World Outdoor collection utilizes EPL-5 treated steel. The EPL-5 treatment is a series of electrolytic processes that combines phosphatizing, electrolytic finishing and polyester varnishing in a uniform application. This same process is used in the automotive and naval industries creating a finish totally resistant to corrosion and UV light. Additionally the treatment makes the steel highly resistant to impact, deformation and chemical damage. It is suited to outdoor use, with a level 5 resistance (on sea craft). The process is environmentally friendly by giving a 100% yield in materials and is low emitting.

Las colecciones Andreu World Outdoor utilizan Acero EPL-5, un método utilizado en la producción de automóviles y que garantiza una gran durabilidad en su uso en el exterior. Se trata de un proceso industrial automatizado, fiable y controlado que proporciona una alta resistencia al impacto, a las deformaciones y a los productos químicos además de permitir su uso en exterior a nivel 5 de resistencia (en cubierta de barco). Además, es un proceso sostenible que permite un 100% de rendimiento de materiales y bajas emisiones.

For / Para:
Brisa
Flex Outdoor
Sand
Siesta
Sit
Sand Table
Siesta Table
Terra
Terra Occasional
Trenza

White Blanco
Earth Brown Marrón Tierra
Titanium Titanio

Certifications / Certificaciones

Durability of exterior-grade furniture Durabilidad del mobiliario de exterior	UNE CEN/TR 581-4
--	------------------

Maintenance and cleaning / Mantenimiento y limpieza

EPL-5 treated steel only requires regular cleaning with soapy water. In the case of stains avoid abrasive sponges or fabrics.
 El acero con tratamiento EPL-5, sólo demanda una limpieza regular con agua jabonosa. En caso de manchas, se deben evitar las esponjas o tejidos abrasivos.

Aluminum / Aluminio

Extremely efficient from a sustainability standpoint, it is 100% recyclable, aluminum is a light, resistant and effective alternative for outdoor furniture.

Extremadamente eficiente desde el punto de vista de la sostenibilidad – es 100% reciclable–, el aluminio es una alternativa ligera, resistente y de contrastada eficacia en la realización de mobiliario de exterior.

For / Para:
Aire
Landscape Alu
Dual
Plaza
Quattro
Raglan Table
Wind

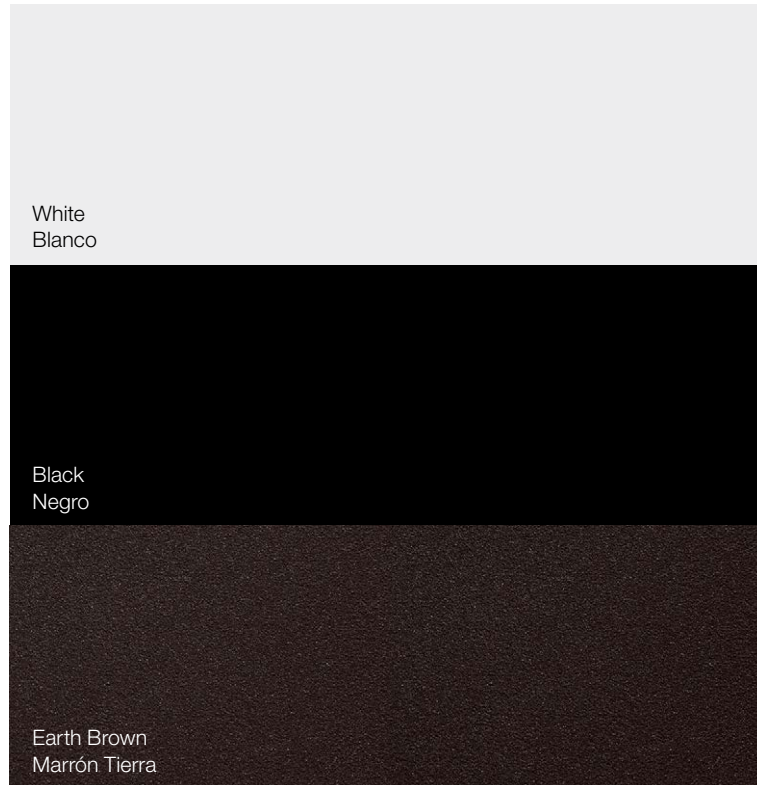

Certifications / Certificaciones

Durability of exterior-grade furniture
 Durabilidad del mobiliario de exterior

UNE CEN/TR 581-4

Maintenance and cleaning / Mantenimiento y limpieza

Occasional cleaning with soapy water.
 Ocasionalmente limpiar con agua y jabón.

Thermo-polymer / Termopolímero

High quality polyamide seat and back of the Andreu World Outdoor collections will include a special outdoor resistant treatment. Our outdoor resistant thermo-polymer is certified by UNE EN 581, which enables us to guarantee the “outdoor resistance” through the passing of time. Thermo-polymer does not require any maintenance. It can be easily cleaned with soap and water.

Los asientos y respaldos de la colección Andreu World Outdoor realizados en termopolímero de alta calidad cuentan con un tratamiento especial para su uso en exterior, según la certificación UNE EN 581, que garantiza su resistencia a la intemperie y al paso del tiempo. No requiere mantenimiento. Su limpieza es sencilla y únicamente requiere agua y jabón.

For / Para:
Flex outdoor
Sail
Sit
Reverse
Reverse Occasional



Certifications / Certificaciones

Resistance to weather and ageing
 Resistencia a la intemperie y al paso del tiempo

UNE EN 581

Resistance, durability and safety
 Resistencia, durabilidad y seguridad

UNE EN 15373

Fire test for public seating
 Test de resistencia al fuego para asientos de uso público

California TB-133

Maintenance and cleaning / Mantenimiento y limpieza

EPL-5 treated steel only requires regular cleaning with soapy water. In the case of stains avoid abrasive sponges or fabrics.
 El acero con tratamiento EPL-5, sólo demanda una limpieza regular con agua jabonosa. En caso de manchas, se deben evitar las esponjas o tejidos abrasivos.

Sand

AW Sand Fabrics are made with solution-dyed acrylic fibers that offer an exceptional combination of strength and functionality. They are created to be strong, durable and resistant. The fabrics are waterproof and due to a unique treatment using nanometric technologies, they are stain resistant, easy to clean and require a minimal maintenance. AW Outdoor Fabrics have been tested in accordance to the maximum environment standards that guarantees that they do not contain any harmful substances. All of these materials have a respect for health.

Los textiles Sand están fabricados con fibras acrílicas teñidas en masa que ofrecen una excepcional combinación de resistencia y funcionalidad. Es resistente al agua y gracias al tratamiento con tecnología nanométrica es resistente a las manchas, fácil de limpiar y requiere un mantenimiento mínimo. Disponen de las máximas certificaciones ambientales y en su fabricación no contiene ninguna sustancia nociva para la salud de las personas.

For / Para:
Aire outdoor
Landscape Alu
Serena Teak
Siesta
Sand
Trenza



Grade 1

Technical specifications / Especificaciones técnicas

Width / Ancho	60 in. /152 cm.
Composition / Composición	100% solution dyed outdoor acrylic fibre / 100% Acrílico teñido en masa
Finish / Acabado	Soil resistant, oil and water-repellent with Teflon finishing, mould resistant. / Resistente al aceite y al agua con acabado de teflón.
Martindale test Cycles / Ciclos	17.000 ISO 13947-2
Color fastness weather conditions / Solidez colores intemperie	7-8 / 8 ISO 105-B04

Maintenance and cleaning / Mantenimiento y limpieza

For good maintenance, do not wipe spilled liquids, clean with a clean/dry cloth. For the cleaning of stains use mild soap diluted in tepid water, and scrub with a soft bristle brush. Rinse thoroughly to remove all soap and let the fabric air dry.
 Para un buen mantenimiento, no frote los líquidos derramados, limpie con un paño limpio y seco. Para la limpieza de manchas utilizar jabón suave diluido en agua tibia, y frotar con un cepillo de cerdas suaves. Enjuagar bien para eliminar todo el jabón y dejar que el tejido se seque al aire.

Solids & Stripes

Woven from solution-dyed acrylic fibers, Natta fabric is specially designed for outdoor use. Its colors hold fast over time and it is highly resistant to water, greasy substances and UV rays. It is easy to maintain and it can remain outdoors for extended periods of time. Maintenance is limited to occasional cleaning with only clean water and a soft brush. Once cleaned, leave it to dry in the open air.

Realizada con tejidos de fibras acrílica teñida en masa, la colección Natta de Sunbrella® está especialmente diseñada para uso en exteriores. Sus colores son duraderos con una buena resistencia al agua, a las grasas y a los rayos UV. Es fácil de mantener y puede permanecer a la intemperie. El mantenimiento se limita al lavado con agua limpia y un suave cepillado. Una vez limpia, deje secar al aire libre.

For / Para:
Aire Outdoor
Landscape Alu
Siesta
Sand
Trenza



Grade 2

Technical specifications / Especificaciones técnicas

Width / Ancho	54 in. /137 cm.
Composition / Composición	100% Sunbrella solution dyed acrylic / 100% Acrílico teñido en masa
Finish / Acabado	Water and Stain resistant. / Resistente al agua y a las manchas.
Tensile strength / Resistencia a la rotura	160 80 daN ISO 13934-1
Martindale test Cycles / Ciclos	15.000-25.000
Color fastness UV / Solidez colores UV	8 class/8 ISO 105-B02
Color fastness weather conditions / Solidez colores intemperie	7/8 class/8 ISO 105-B04

Maintenance and cleaning / Mantenimiento y limpieza

For good maintenance, do not wipe spilled liquids, clean with a clean/dry cloth. For the cleaning of stains use mild soap diluted in tepid water, and scrub with a soft bristle brush. Rinse thoroughly to remove all soap and let the fabric air dry.
 Para un buen mantenimiento, no frote los líquidos derramados, limpie con un paño limpio y seco. Para la limpieza de manchas utilizar jabón suave diluido en agua tibia, y frotar con un cepillo de cerdas suaves. Enjuagar bien para eliminar todo el jabón y dejar que el tejido se seque al aire.

Silvertex

It is an 100% vinyl collection with protective vinyl coating designed to be a resistant barrier against germs, abrasion and stains. Developed with PermeaBlok3®, a proven protective layer of vinyl that is designed to create a tough, effective barrier against germs, abrasion and stains. In addition, it is resistant to water and UV rays.

Es una colección 100% vinil, recubrimiento protector de vinilo diseñado para conseguir una barrera resistente contra los gérmenes, la abrasión y las manchas. Se desarrolla con PermeaBlok3®, una capa protectora de vinilo demostrado que está diseñado para crear una dura barrera eficaz contra los gérmenes, la abrasión y las manchas. Además, es resistente al agua y rayos UV.

For / Para:
Aire Outdoor
Landscape Alu
Siesta
Sand
Trenza



Grade 2

Technical specifications / Especificaciones técnicas

Width / Ancho	54 in./137 cm.
Composition Composición	Polyester Hi-loft2 Poliéster Hi-loft2
Assessment of inability Reacción al fuego	FMVSS 302, IMO A.652(16)8.2 and 8.3, FAR 25.853(A) 1&2, DIN 4102 (B2), Önorm B 3825, Önorm B 3800 Teil 1, CALIFORNIA TECH. BULLETIN 117-Section E, BIFMA X5.7-Fabric Class-Class A, BIFMA X5.7-Fabric Screening-Class I, UFAC Fabric-Class I, NFPA 260-Cover Fabric-Class I, NFP 92.503, EN 71-2, UNI 9175, DIRECTIVA 95/28/CE.
Martindale test Cycles / Ciclos	>100.000
Galling resistance / Resistencia al roce	CFFA 7 AATCCTM 8

Color fastness to light / Solidez a la luz	DIN 54004 100 hours/horas
Suitable for loose cover Válido para funda	No
Additional Notes Observaciones	Permeablok3. Advanced vinyl protection. Silverguard: Silver Ion Technology.

Maintenance and cleaning / Mantenimiento y limpieza

It is recommended to clean it periodically in order to maintain its appearance and prevent the accumulation of dirt and contaminants. Es recomendable limpiarlo periódicamente con el fin de mantener su apariencia y evitar la acumulación de suciedad y contaminantes.

Natte

Woven from solution-dyed acrylic fibers, Natte fabric is specially designed for outdoor use. Its colors hold fast over time and it is highly resistant to water, greasy substances and UV rays. It is easy to maintain.

Maintenance is limited to occasional cleaning with only clean water and a soft brush. Once cleaned, leave it to dry in the open air.

Realizada con tejidos de fibras acrílica teñida en masa, la colección Natte de Sunbrella® está especialmente diseñada para uso en exteriores. Sus colores son duraderos con una buena resistencia al agua, a las grasas y a los rayos UV. Es fácil de mantener. El mantenimiento se limita al lavado con agua limpia y un suave cepillado. Una vez limpia, deje secar al aire libre.

For / Para:
Aire Outdoor
Landscape Alu
Siesta
Sand
Trenza



Grade 3

Technical specifications / Especificaciones técnicas

Width / Ancho	55 in. /140 cm.
Composition Composición	100% Sunbrella solution dyed acrylic 100% Acrílico teñido en masa
Finish Acabado	Water and Stain resistant. Resistente al agua y a las manchas.
Tensile strength / Resistencia a la rotura	180 100 daN ISO 13934-1
Martindale test Cycles / Ciclos	10.000
Color fastness UV / Solidez colores UV	7/8 class/8 ISO 105-B02
Color fastness weather conditions Solidez colores intemperie	7/8 class/5 ISO 105-B04

Maintenance and cleaning / Mantenimiento y limpieza

For good maintenance, do not wipe spilled liquids, clean with a clean/dry cloth. For the cleaning of stains use mild soap diluted in tepid water, and scrub with a soft bristle brush. Rinse thoroughly to remove all soap and let the fabric air dry. Para un buen mantenimiento, no frote los líquidos derramados, limpie con un paño limpio y seco. Para la limpieza de manchas utilizar jabón suave diluido en agua tibia, y frotar con un cepillo de cerdas suaves. Enjuagar bien para eliminar todo el jabón y dejar que el tejido se seque al aire.

Chartres

Its finish gives its namesake look of natural linen. The textile is a woven from solution-dyed acrylic fibers. It is specially designed for outdoor use. They come in monotone, durable colors, offering good resistance to water, oils and UV rays. They are fully resistant to splitting and abrasion.

Su textura y material le da un aspecto muy natural. Chartres está realizada con tejidos de fibras acrílica teñida en masa. Especialmente diseñada para uso en exteriores sus colores son duraderos y ofrecen una buena resistencia al agua, a las grasas y a los rayos UV. Es fácil de mantener y puede permanecer a la intemperie.

For / Para:
Aire Outdoor
Landscape Alu
Siesta
Sand
Trenza



Grade 6

Technical specifications / Especificaciones técnicas

Width / Ancho	54 in. /137 cm.
Composition / Composición	100% Sunbrella solution dyed acrylic / 100% Acrílico teñido en masa
Finish / Acabado	Water and Stain resistant. / Resistente al agua y a las manchas.
Tensile strength / Resistencia a la rotura	183 127 daN ISO 13934-1
Martindale test Cycles / Ciclos	24.000
Color fastness UV / Solidez colores UV	8 class/ 8 ISO 105-B02
Color fastness weather conditions / Solidez colores intemperie	4-5 class / 5 ISO 105-B04

Maintenance and cleaning / Mantenimiento y limpieza

For good maintenance, do not wipe spilled liquids, clean with a clean/dry cloth. For the cleaning of stains use mild soap diluted in tepid water, and scrub with a soft bristle brush. Rinse thoroughly to remove all soap and let the fabric air dry.
 Para un buen mantenimiento, no frote los líquidos derramados, limpie con un paño limpio y seco. Para la limpieza de manchas utilizar jabón suave diluido en agua tibia, y frotar con un cepillo de cerdas suaves. Enjuagar bien para eliminar todo el jabón y dejar que el tejido se seque al aire.

Lopi

Woven from solution-dyed acrylic fibers, Natta fabric is specially designed for outdoor use. Its colors hold fast over time and it is highly resistant to water, greasy substances and UV rays. It is easy to maintain and it can remain outdoors for extended periods of time. Maintenance is limited to occasional cleaning with only clean water and a soft brush. Once cleaned, leave it to dry in the open air.

Realizada con tejidos de fibras acrílica teñida en masa, la colección Lopi de Sunbrella® está especialmente diseñada para uso en exteriores. Sus colores son duraderos con una buena resistencia al agua, a las grasas y a los rayos UV. Es fácil de mantener y puede permanecer a la intemperie. El mantenimiento se limita al lavado con agua limpia y un suave cepillado. Una vez limpia, deje secar al aire libre.

For / Para:
Aire Outdoor
Landscape Alu
Siesta
Sand
Trenza



Grade 8

Technical specifications / Especificaciones técnicas

Width / Ancho	54 in. /137 cm.
Composition / Composición	100% Sunbrella solution dyed acrylic / 100% Acrílico teñido en masa
Finish / Acabado	Water and Stain resistant. / Resistente al agua y a las manchas.
Tensile strength / Resistencia a la rotura	339 188 daN ISO 13934-1
Martindale test Cycles / Ciclos	36.000
Color fastness UV / Solidez colores UV	8 class/8 ISO 105-B02
Color fastness weather conditions / Solidez colores intemperie	4-5 class/5 ISO 105-B04

Maintenance and cleaning / Mantenimiento y limpieza

For good maintenance, do not wipe spilled liquids, clean with a clean/dry cloth. For the cleaning of stains use mild soap diluted in tepid water, and scrub with a soft bristle brush. Rinse thoroughly to remove all soap and let the fabric air dry.
 Para un buen mantenimiento, no frote los líquidos derramados, limpie con un paño limpio y seco. Para la limpieza de manchas utilizar jabón suave diluido en agua tibia, y frotar con un cepillo de cerdas suaves. Enjuagar bien para eliminar todo el jabón y dejar que el tejido se seque al aire.

Batyline

PVC-thread fabrics. Long-lasting color stability, resistant to microorganisms, flexible and resistant to mechanical stress. Easy drying and coolness, even in bright sunlight. Highly fire resistant.

Tejidos compuestos a base de hilos de PVC. Estabilidad del color con el paso del tiempo, resistente a los microorganismos, flexible y resistente a los esfuerzos mecánicos. Facilidad de secado y frescura, incluso a pleno sol. Presenta una alta resistencia al fuego.

For / Para:
Aire Outdoor

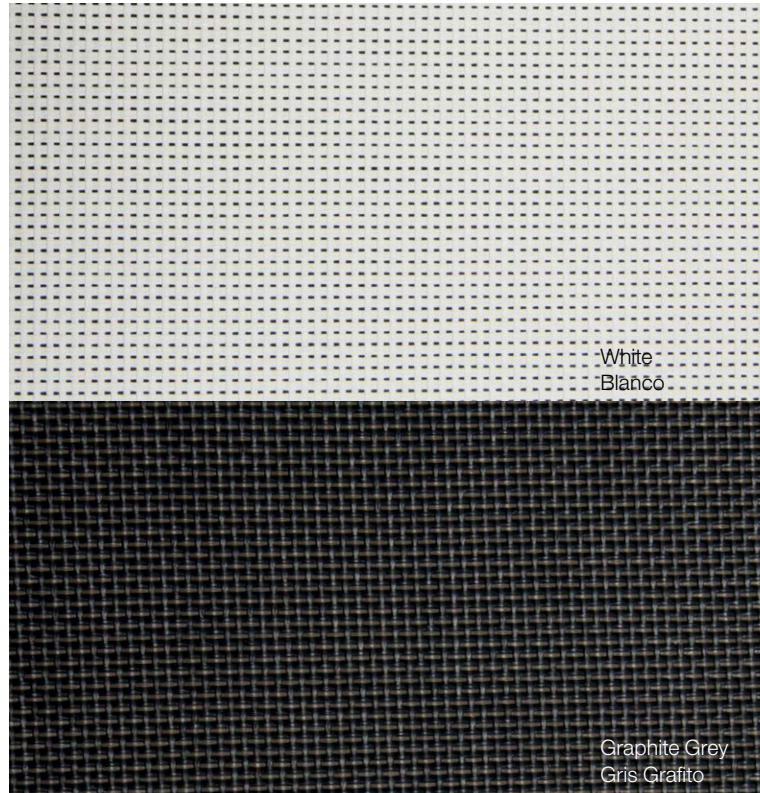

Certifications / Certificaciones

ISO 9001	Quality certificate / Certificado de calidad
ISO 14001	Environmental management / Respecto mediambiental
EN ISO 1421	Breakage strength (warp/weft) / Resistencia a la rotura (urdimbre/trama)
DIN 53.363	Tear strength (warp/weft) / Resistencia al desgarr (urdimbre/trama)
EN ISO 846	Resistance to mould-fungi / Resistencia al moho
NFP 92 507	Resistance to fire / Resistencia al fuego
EN ISO 12947-2	Abrasion resistance by the Martindale method > 40,000 cycles / Reacción a la abrasión Martindale > 40.000 ciclos
ISO 105 B02	Color fastness to conventional light Xenotest 700 hours / Estabilidad luz convencional Xenotest 700 horas
QUV TEST T30-036	Colorfastness extreme light UVA 340 lamp 2000 hours / Estabilidad luz extrema Lámpara UVA 340 2.000 horas

Maintenance and cleaning / Mantenimiento y limpieza

Requires no more than light brushing with soapy water. Wipe off bird droppings as soon as possible, as they can cause damage and permanent stains on the Batyline®. Solo precisa un ligero cepillado con agua jabonosa. Limpiar los restos de excrementos de aves lo antes posible ya que pueden ser particularmente perjudiciales y causar manchas permanentes en el Batyline®.

Woven band / Cincha

Polypropylene bands are 1.57 inches (40 mm) in width. They are fully resistant to UV rays and the elements which makes them perfectly suited for outdoor use. They are certified to ISO 105-B02 for their color fastness in outdoor applications and only require regular cleaning with soapy water.

Está realizada en polipropileno de 40mm de anchura, con protección a los rayos UV y la los agentes climáticos que caracterizan el uso de exterior. Tiene la certificación ISO 105-B02 respecto a la solidez del color a la intemperie y sólo reclama una limpieza regular con agua y jabón.

For / Para:
Brisa Sand Trenza



Certifications / Certificaciones

Color fastness to light / Solidez del color a la luz	ISO 105-B02
Rubbing fastness / Solidez al rozamiento	ISO 105-X12
Color fastness to chlorinated water (pool water) / Solidez de color al agua clorada (agua de piscina)	ISO 105-E03

Maintenance and cleaning / Mantenimiento y limpieza

To clean, gently wipe the belts using a brush and soapy water. Rinse with water and allow to air dry. Para la limpieza se recomienda frotar suavemente las cintas con un cepillo y agua jabonosa. Posteriormente aclarar con agua y dejar secar al aire libre.

Covers / Fundas

The protective covers are made of waterproof polyester fabric which protects the furniture from moisture, rain and sun. They can be used to cover the furniture when it is stored or during particularly bad weather conditions.

Las fundas de protección están confeccionadas en tejido impermeable de poliéster que protegen el mobiliario de la humedad, la lluvia y el sol. Permiten resguardar el mobiliario cuando no se utiliza o cuando las condiciones meteorológicas son especialmente adversas.

For / Para:
Landscape Alu
Siesta
Sand
Wind

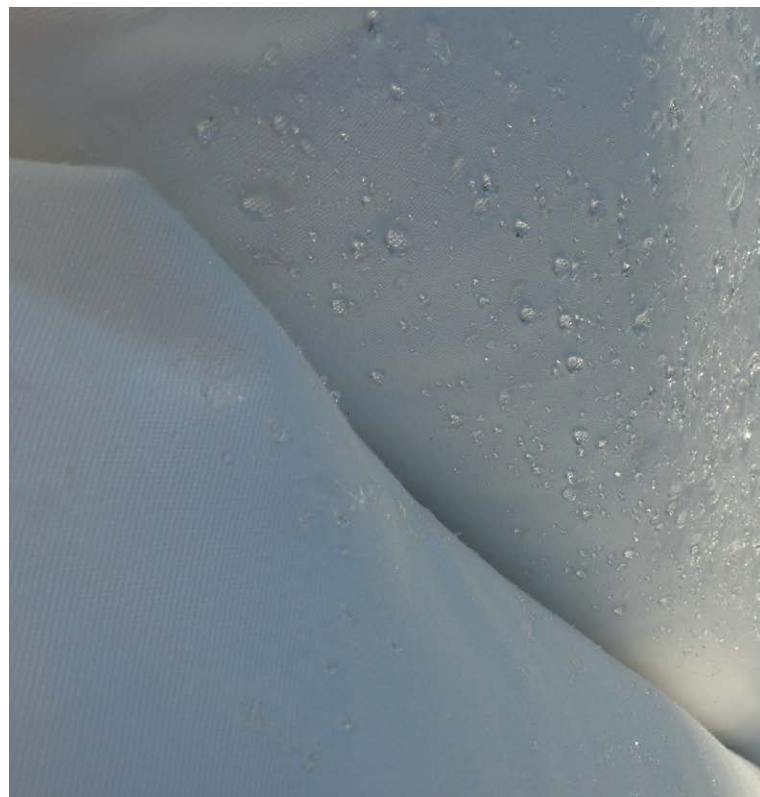

Cushions / Cojines

These cushions are tested for intensive outdoor use and are 100 percent breathable. Their interior is composed of a waterproof filler with a polypropylene cover that is also water resistant.

The foams utilized are quick dry (dry foam) thanks to its open cellular structure so that the air can freely circulate. The water passes through the filling, but it dries rapidly due to its large open pores inhibiting the growth of fungus and bacteria. Additionally, the seams are protected both interiorly and exteriorly with an extra covering.

Estos cojines están testados para su uso intensivo en el clima y son 100% transpirable. Su interior está compuesto de rellenos hidrófugos con una cubierta de polipropileno repelente al agua.

Las espumas utilizadas son de secado rápido (dryfoam) gracias a su estructura celular abierta para que el aire pueda circular libremente. El agua pasa a través del relleno, pero se seca rápidamente gracias a los grandes poros abiertos, de la espuma, inhibiendo el crecimiento fúngico y bacteriano. Además, las costuras están protegidas tanto en el interior como en el exterior con un recubrimiento extra.

For / Para:
Landscape Alu
Siesta
Sand
Trenza



Special thanks

Agradecimientos

La butiq Restaurant

Isabel López Vilalta

Restaurante Disfrutar

Barcelona

Restaurante Dos Torres

Barcelona

Restaurante El Filete Ruso

Barcelona

Hotel Brummell

Barcelona

Hotel Pullman Skipper

Barcelona

Restaurante Attic

Barcelona

MUVIM Museum

Carmen Baselg_Taller de proyectos

Pereira Miguel Arquitectos

www.japfp.com

Minim

www.minim.es

Resort L'and Vineyards

www.l-and.com

SMON Barcelona

www.smonbcn.es

ACCIONS

www.accionsbcn.com

Designers

Diseñadores

Lievore Altherr Molina

Piergiorgio Cazzaniga

Estudio Andreu

Photography

Fotografía

Eugení Pons

Gerald Kiernan

Salva López

Elena Mahugo

Marc Liens

Fernando Alda

Héctor Rubio

Art direction

Dirección de arte

Lievore Altherr Molina

Laura Armet (Emeyele)

Graphic design

Diseño gráfico

Laura Armet (Emeyele)

Andreu World S.A.

Copyright©AndreuWorld,

07 / 2017

Printed in Spain

Esta publicación no puede ser reproducida en todo o en parte sin el permiso escrito del editor. Todos los modelos están protegidos mediante patente internacional.

This publication may not be reproduced in whole or in part in any manner whatsoever without the written permission of the publisher. All models are protected by international patent.

The paper used to produce this catalog comes from responsibly managed forests and other controlled sources for greater environmental protection.

El papel utilizado para producir este catálogo proviene de bosques gestionados de forma responsable y de otras fuentes controladas que garantizan la protección del medio ambiente.



The mark of responsible forestry



UNE EN ISO
9001



UNE EN ISO
14001



ISO 14006
Ecodesign
Ecodiseño



100% Design
Protection

100% Protección
del Diseño



National Design
Award

Premio Nacional
de Diseño

